

# DWARSPROFIELEN THOLEN (5)

SCHAAL 1:200

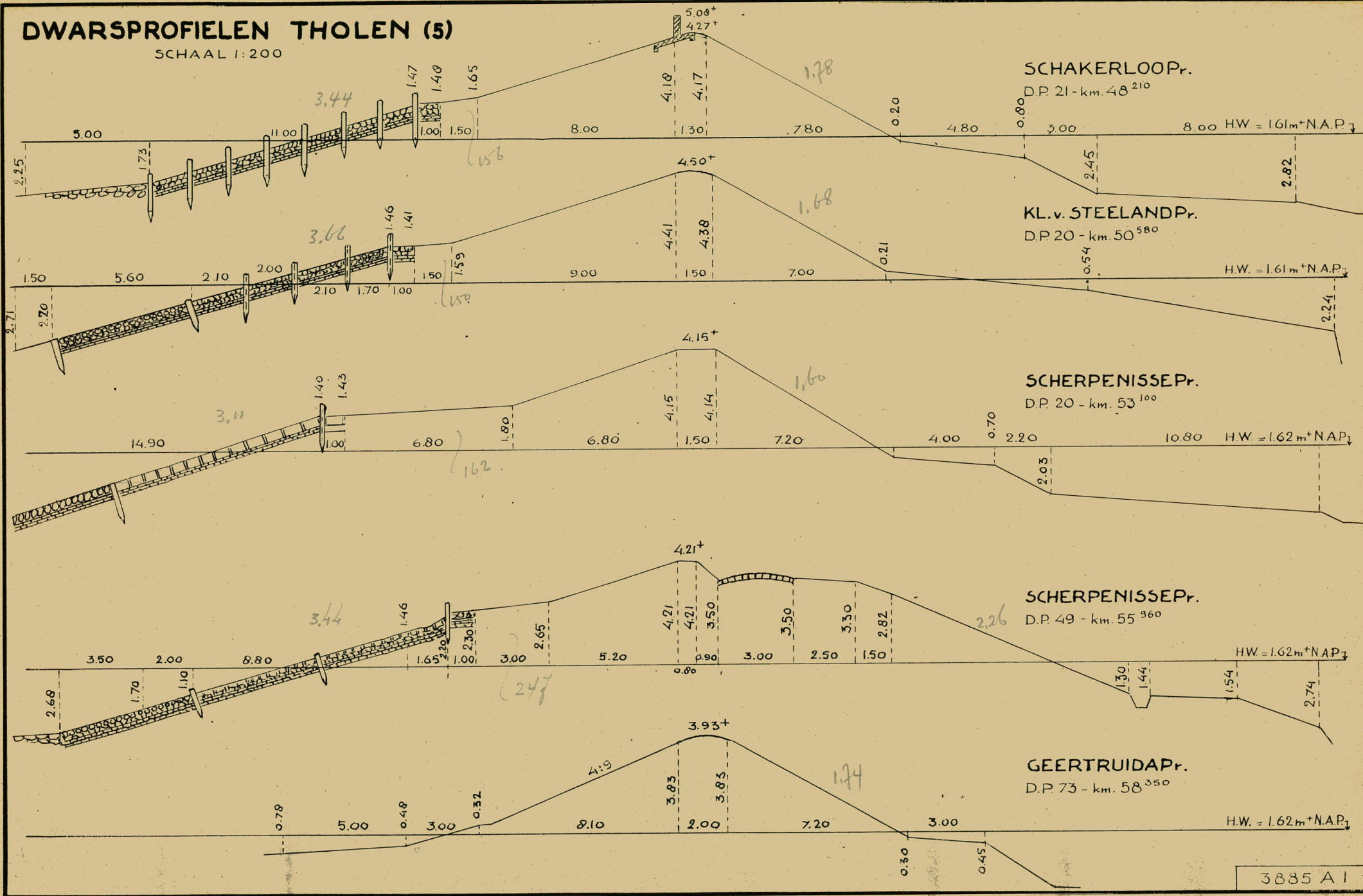

BULAGE

# DWARSPROFIELEN THOLEN (6 SLOT)

SCHAAL: 1:200

## SCHERPENISSEPR.

D.P. 86 - km. 59<sup>650</sup>

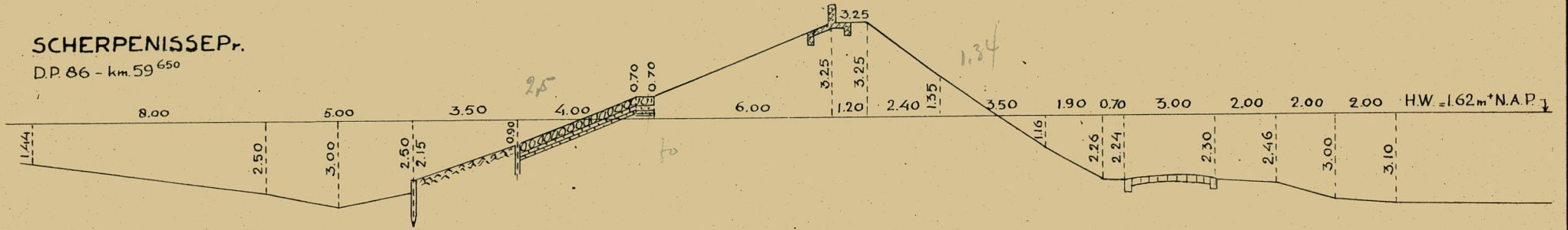

## SLABBECOORNPR.

km. 61<sup>300</sup>

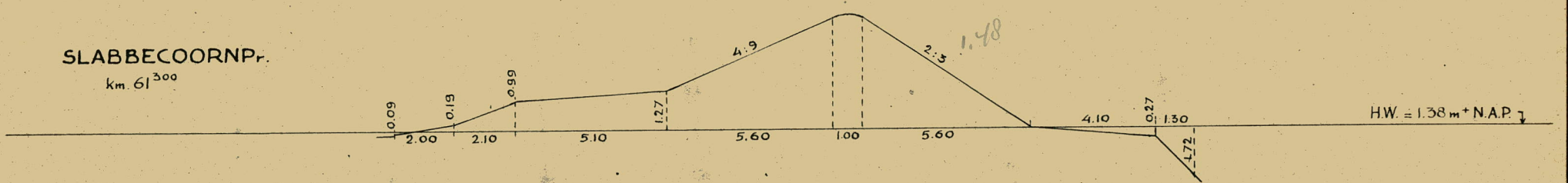



# SITUATIE

SCHOUWEN DUIVELAND

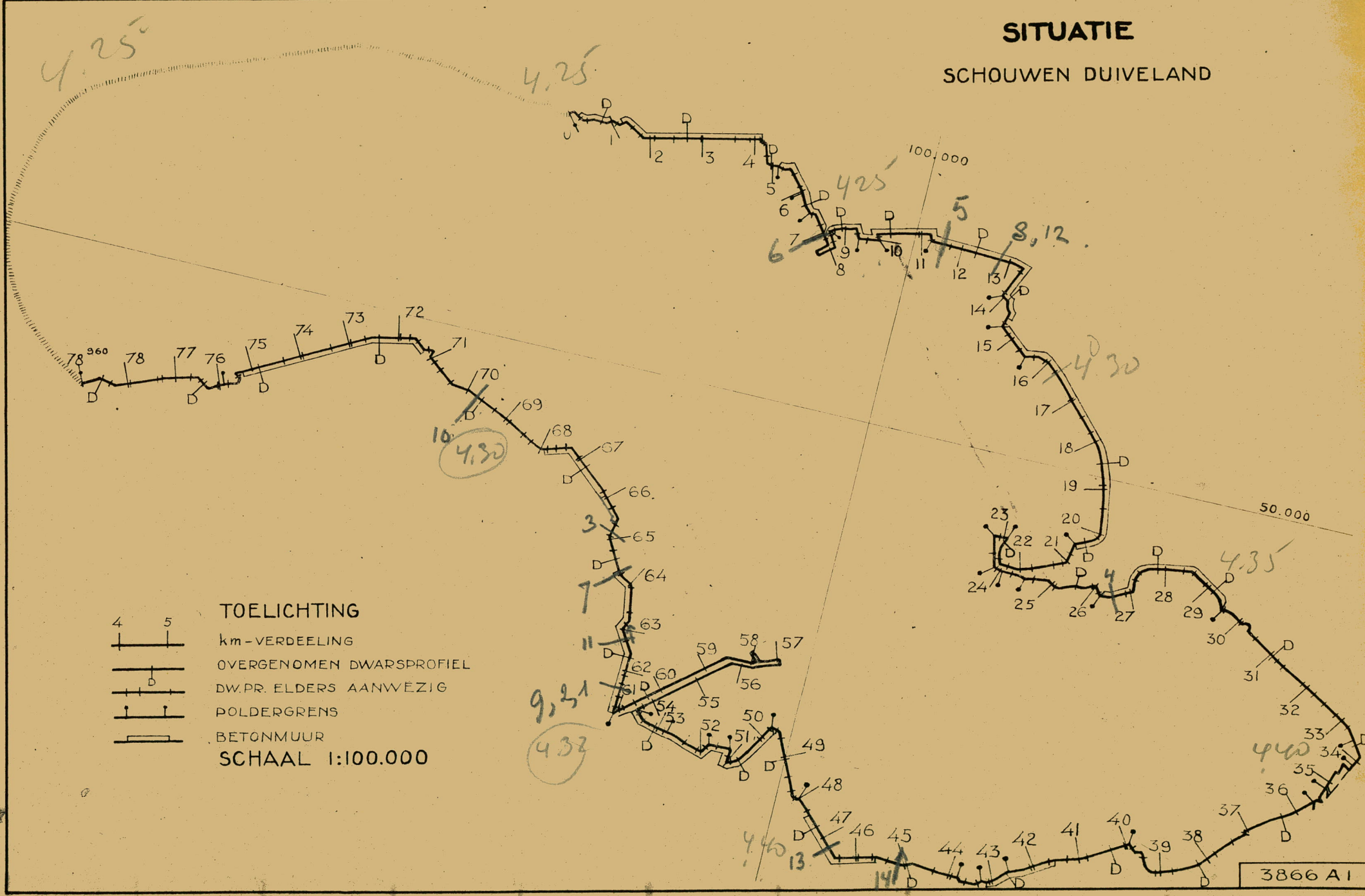

## TOELICHTING

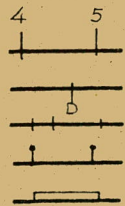

- 4 km-VERDEELING
- 5 OVERGENOMEN DWARSPROFIEL
- D DW.PR. ELDERS AANWEZIG
- POLDERGREN
- BETONMUUR
- SCHAAL 1:100.000

BULAGE

50

# GEM. DIJKSKRUINHOGTE PER k.m.

WATERPASSING NAJAAR 1923  
BUGEWERKT TOT JAN. 1943

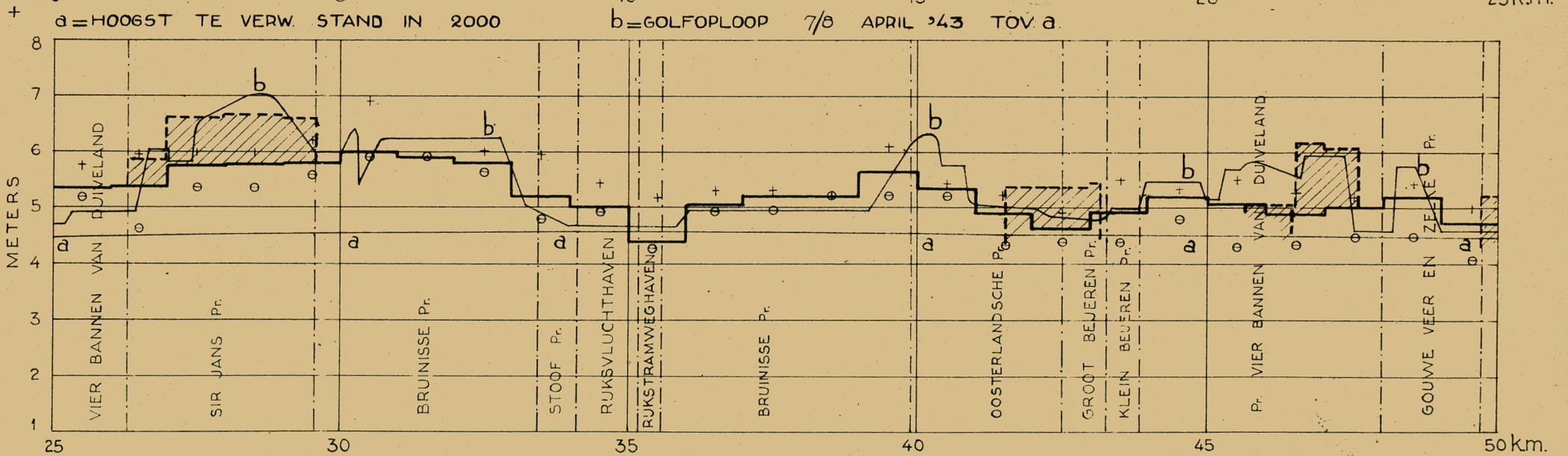
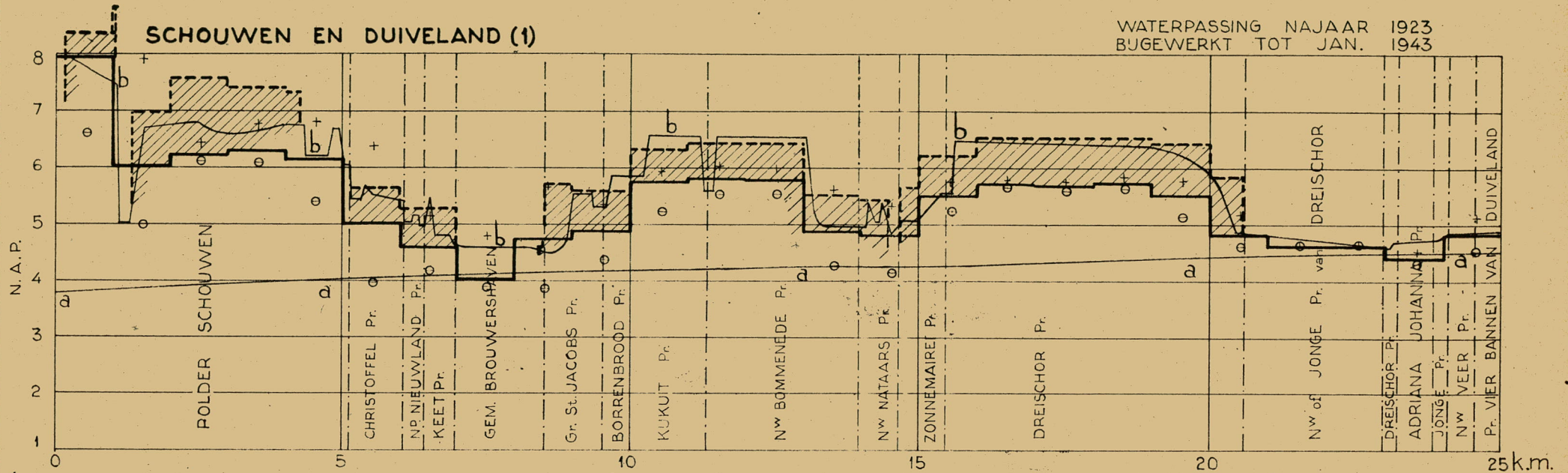

BULAGE 51



# GEM. DIJKSKRUINHOOGTE PER k.m.

WATERPASSING NAJAAR 1923  
BUGEWERKT TQT JAN 1943

## SCHOUWEN EN DUIVELAND (2)

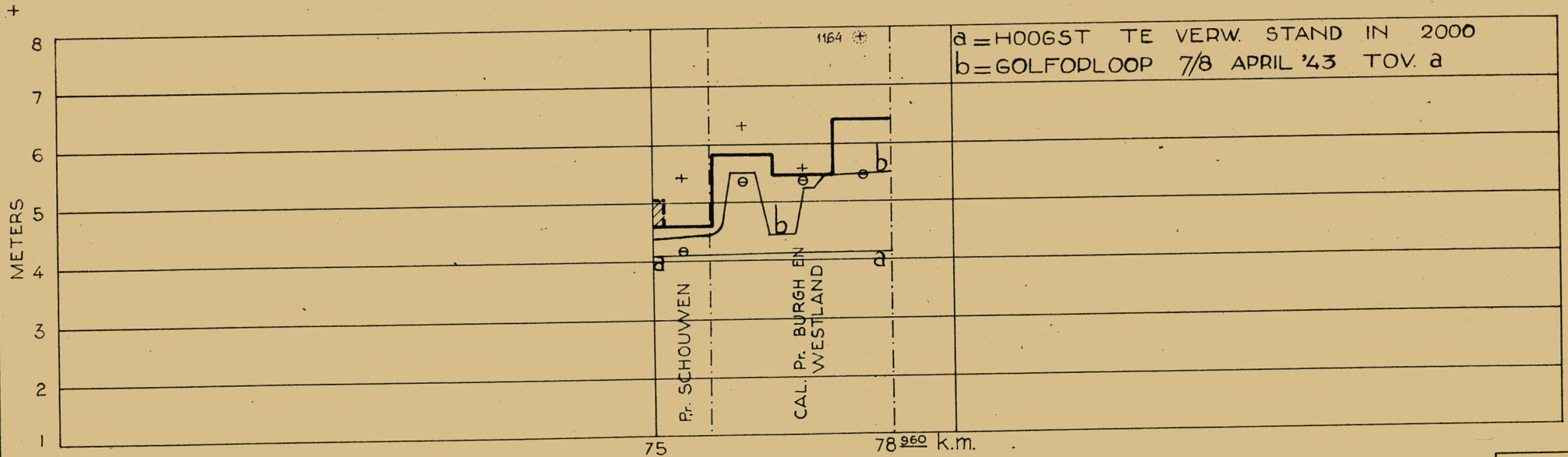
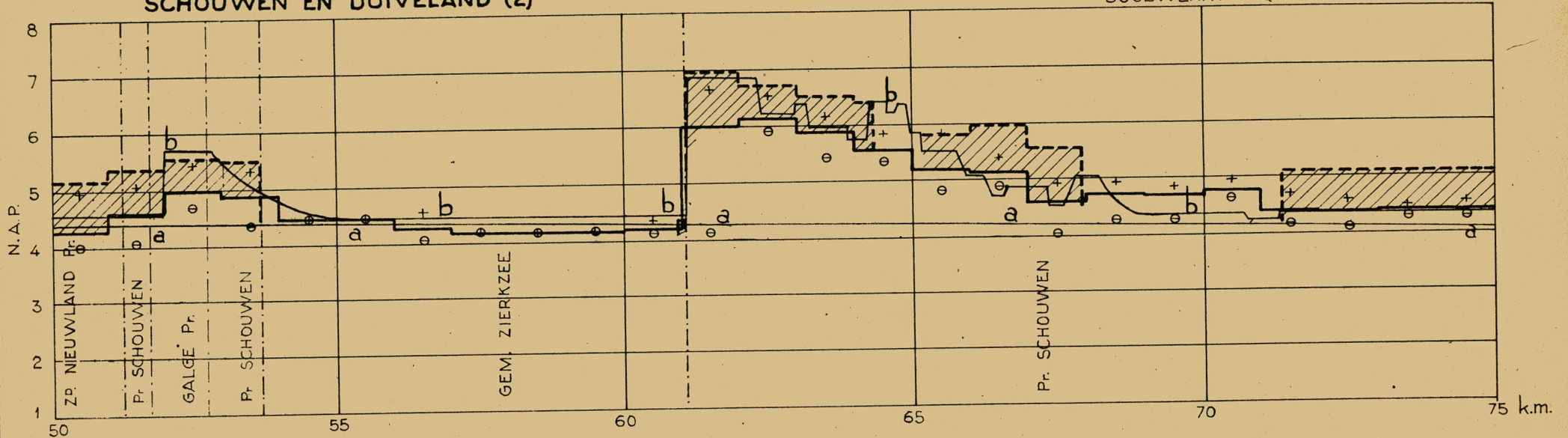

BULAGE 2

# DWARSPROFIELEN SCHOUWEN EN DUIVELAND (1)

SCHAAL 1:200

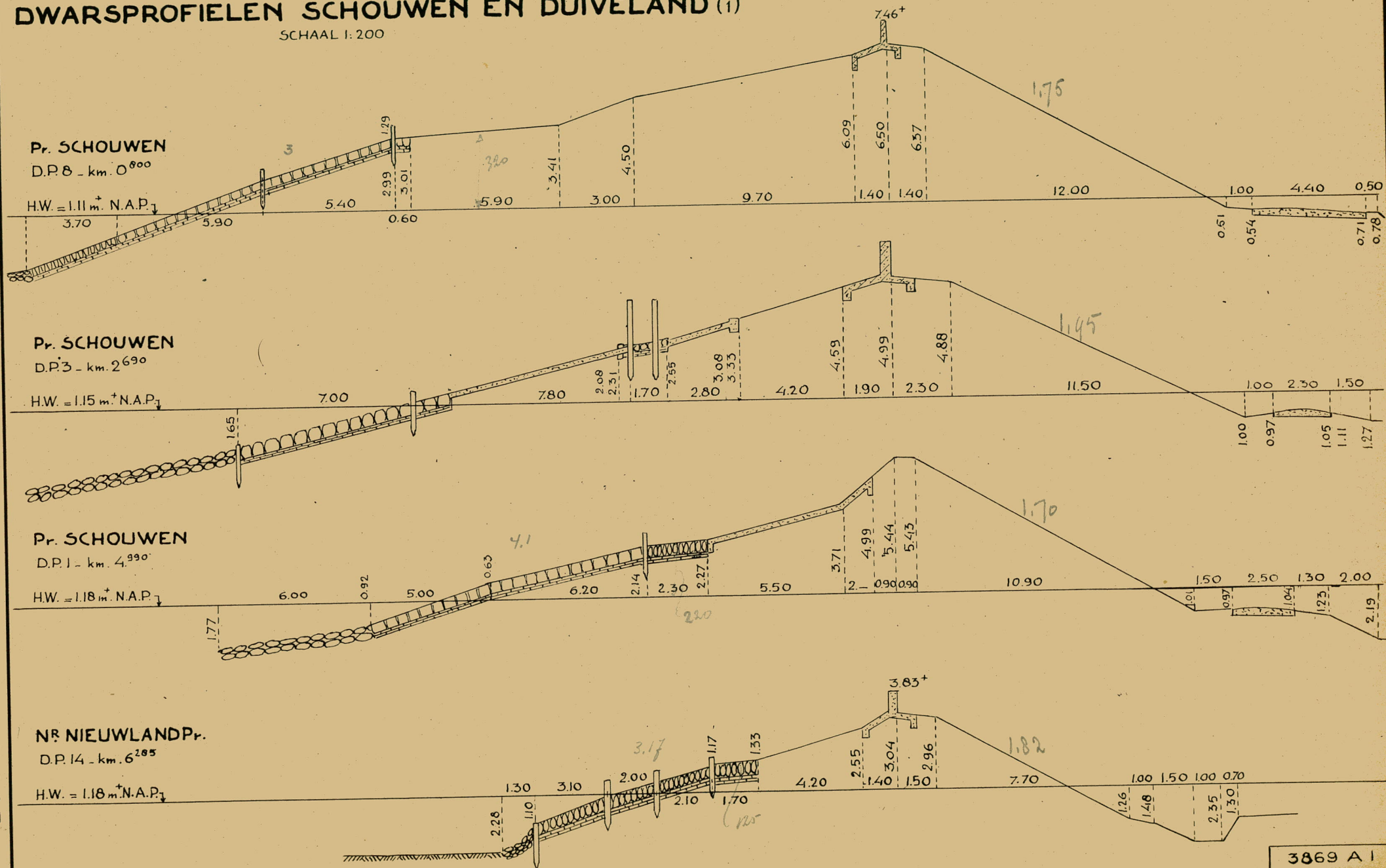

BULAGE

53



# DWARSPROFIELEN SCHOUWEN EN DUIVELAND (2)

SCHAAL 1:200

## GROOT ST. JACOBS Pr.

D.P. 26 - km. 8<sup>960</sup>

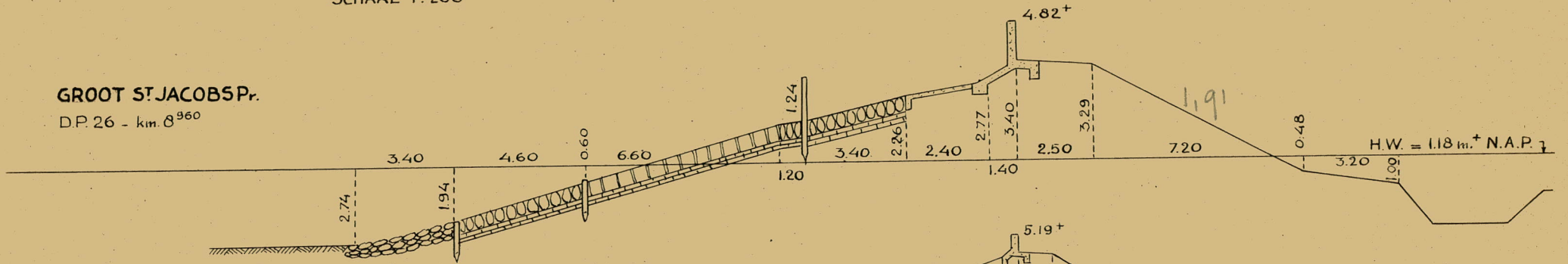

## KUKUIT Pr.

D.P. 4 - km. 10<sup>410</sup>

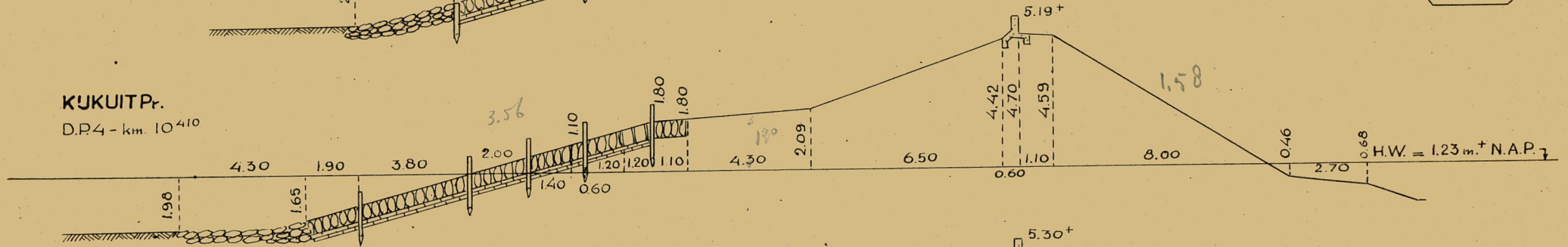

## NW BOMMENEDE Pr.

D.P. 23 - km. 12<sup>320</sup>

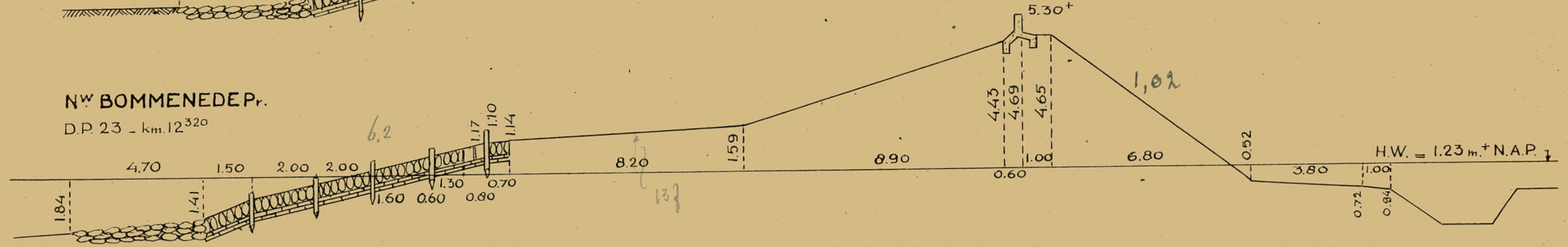

## NW NATAARS Pr.

D.P. 41 - km. 14<sup>100</sup>

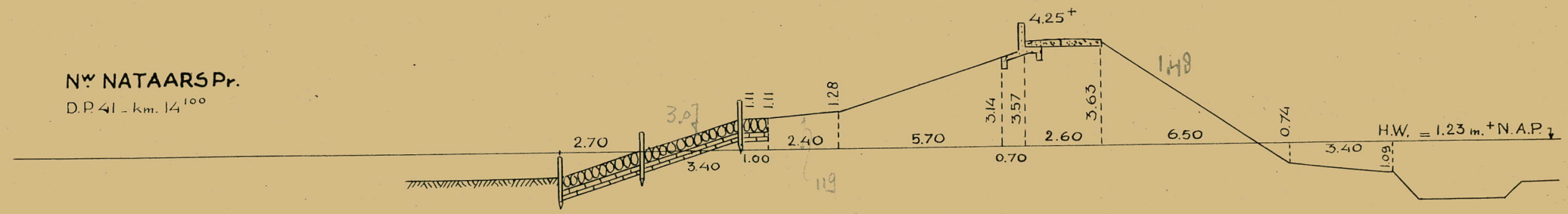

BIJLAGE 54

# DWARSPROFIELEN SCHOUWEN EN DUIVELAND (3)

SCHAAL 1:200

DREISCHORPr.

D.P. 73 km 16<sup>240</sup>

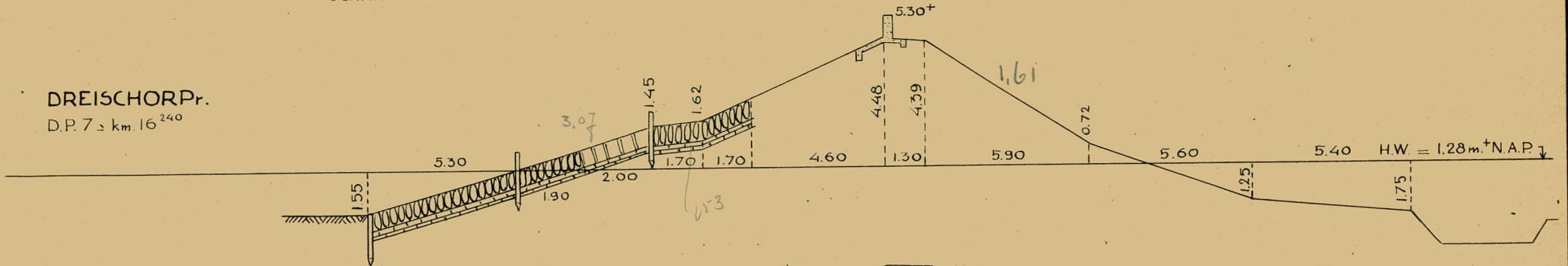

DREISCHORPr.

D.P. 29 km 18<sup>480</sup>

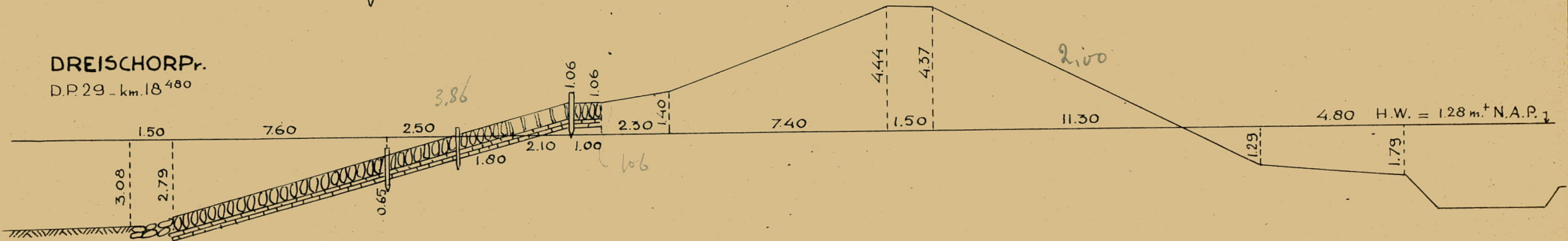

DREISCHORPr.

D.P. 47 km 20<sup>390</sup>

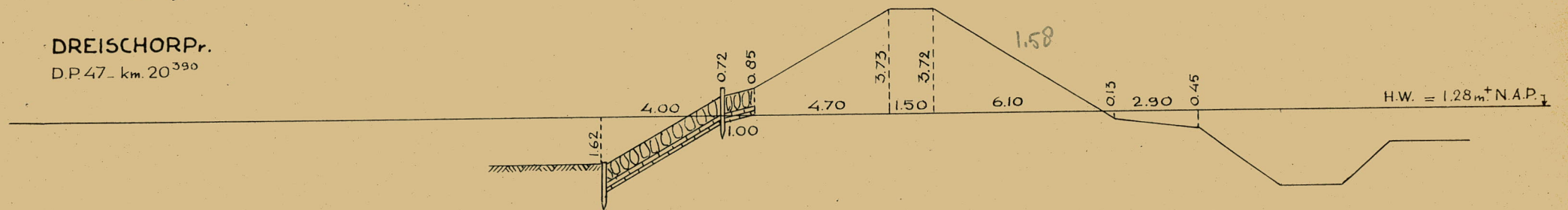

NWE of JONGE DREISCHORPr.

D.P. 23 km 22<sup>900</sup>

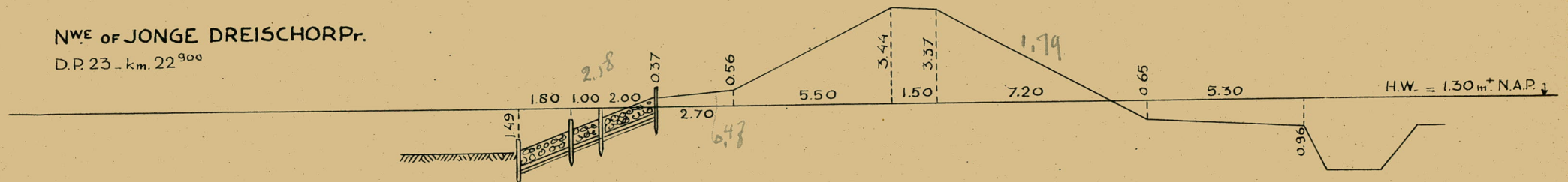

BULAGE 55



# DWARSPROFIELEN SCHOUWEN EN DUIVELAND (4)

SCHAAL 1:200

## VIER BANNENPr.

D.P. II - km. 25<sup>560</sup>

H.W. = 1.32 m<sup>+</sup> N.A.P. ↓

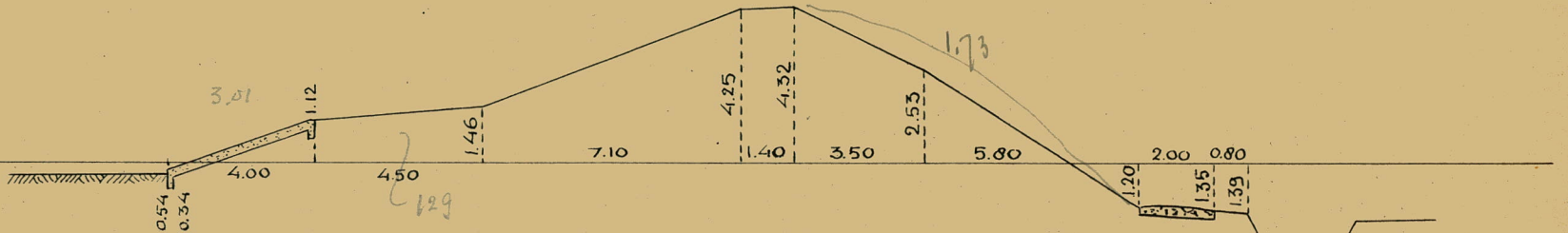

## SIR JANSLANDPr.

D.P. 17 - km. 27<sup>850</sup>

H.W. = 1.33 m<sup>+</sup> N.A.P. ↓

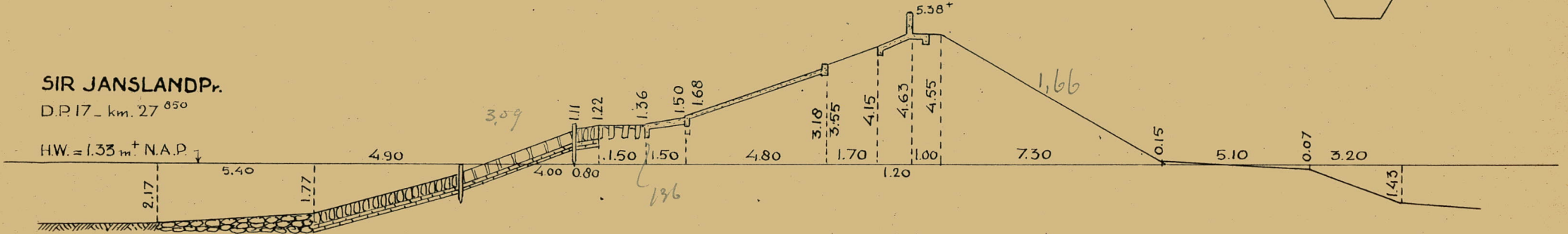

## SIR JANSLANDPr.

D.P. 4 - km. 29<sup>160</sup>

H.W. = 1.33 m<sup>+</sup> N.A.P. ↓

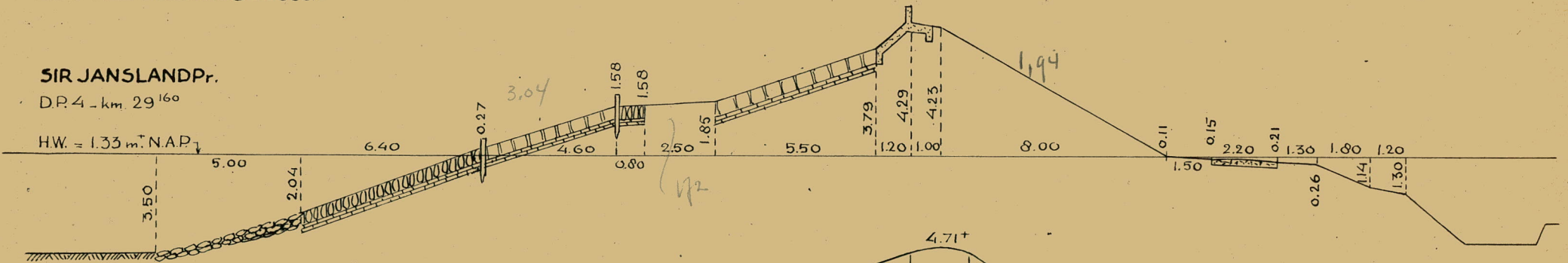

## BRUINISSEPr.

D.P. 15 - km. 31<sup>000</sup>

H.W. = 1.40 m<sup>+</sup> N.A.P. ↓

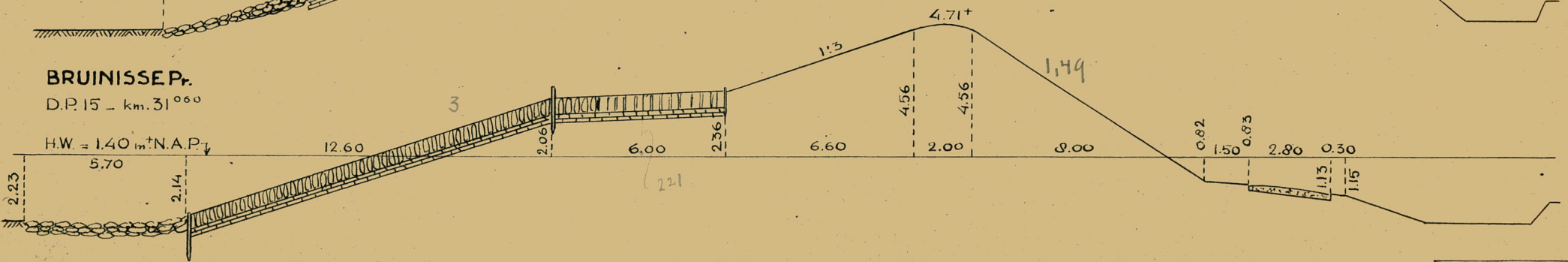

BULAGE 56

# DWARSPROFIELEN SCHOUWEN EN DUIVELAND (5)

SCHAAL 1:200

STOOFPr.

D.P. 40 - km. 33<sup>600</sup>

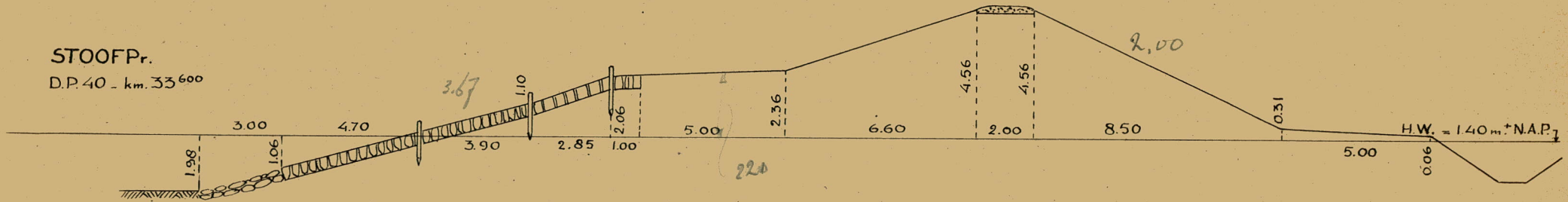

BRUINISSEPr.

D.P. 64 - km. 36<sup>300</sup>

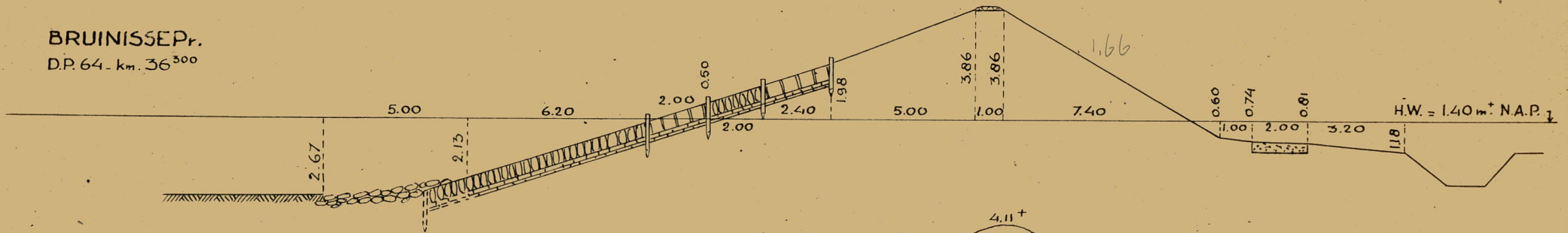

BRUINISSEPr.

D.P. 83 - km. 38<sup>200</sup>

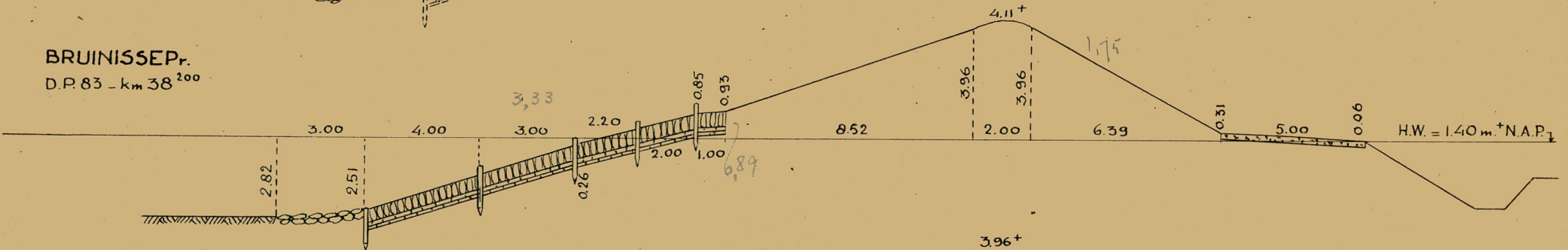

OOSTERLANDSCHE Pr.

D.P. 34 - km. 40<sup>330</sup>

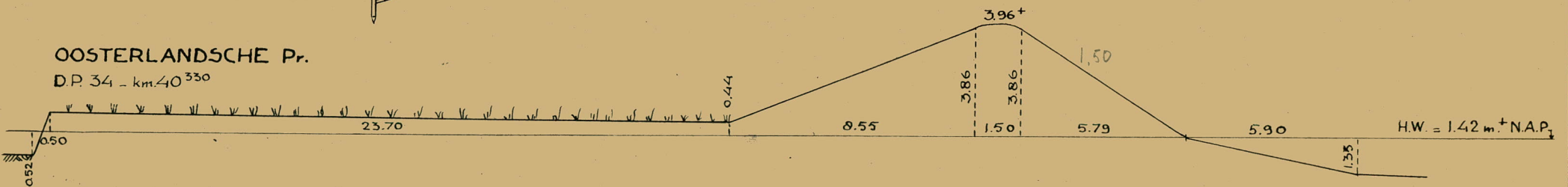

BILAGE 7



# DWARSPROFIELEN SCHOUWEN EN DUIVELAND (6)

SCHAAL 1:200

GROOT BEJEREN Pr.

D.P. II - km. 42<sup>660</sup>

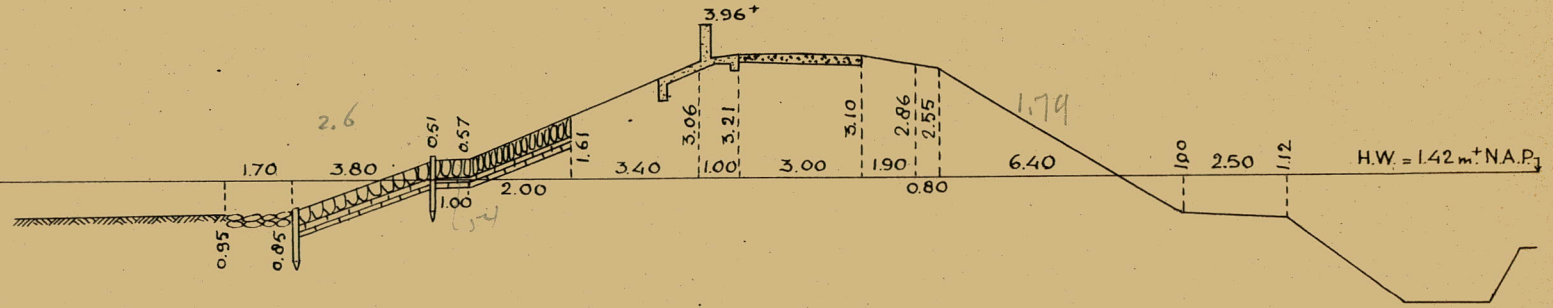

VIER BANNEN Pr.

D.P. 12 - km. 44<sup>940</sup>

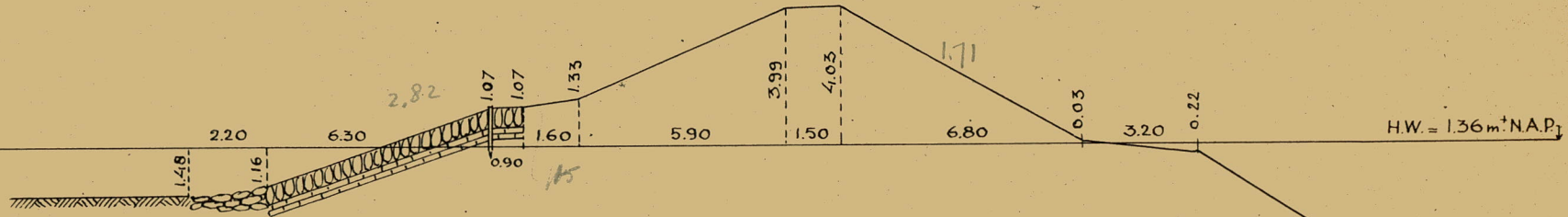

VIER BANNEN Pr.

D.P. 35 - km. 47<sup>280</sup>

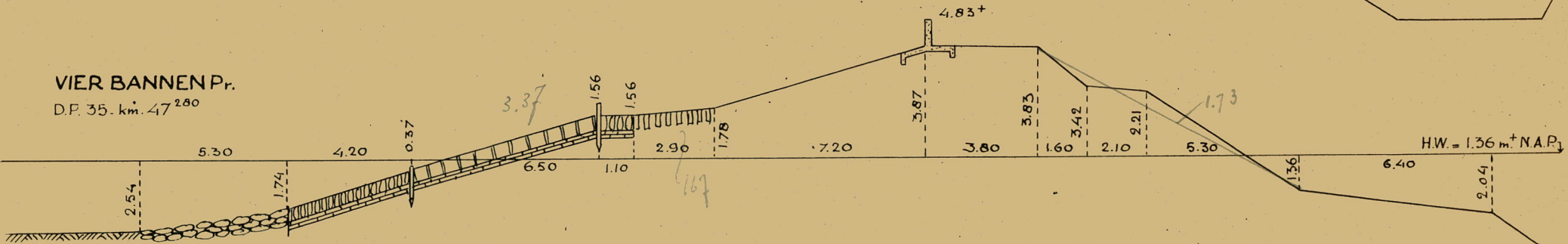

GOUWE VEER EN ZELKE Pr.

D.P. 10 - km. 48<sup>980</sup>

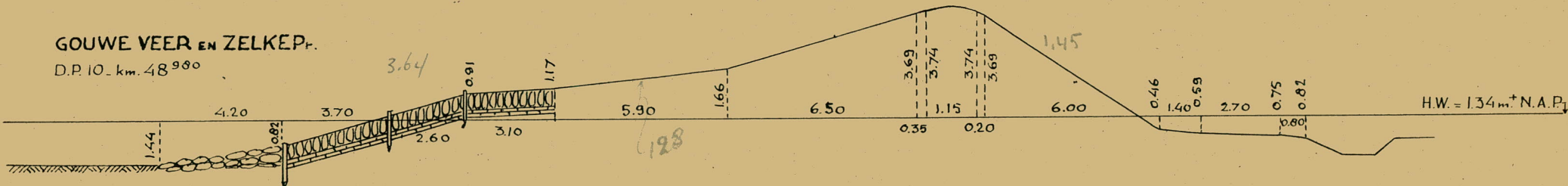

BULAGE

# DWARSPROFIELEN SCHOUWEN EN DUIVELAND (7)

SCHAAL 1:200

## GALGE Pr.

D.P. 10 - km. 50<sup>720</sup>

H.W. = 1.30 m<sup>+</sup> N.A.P.

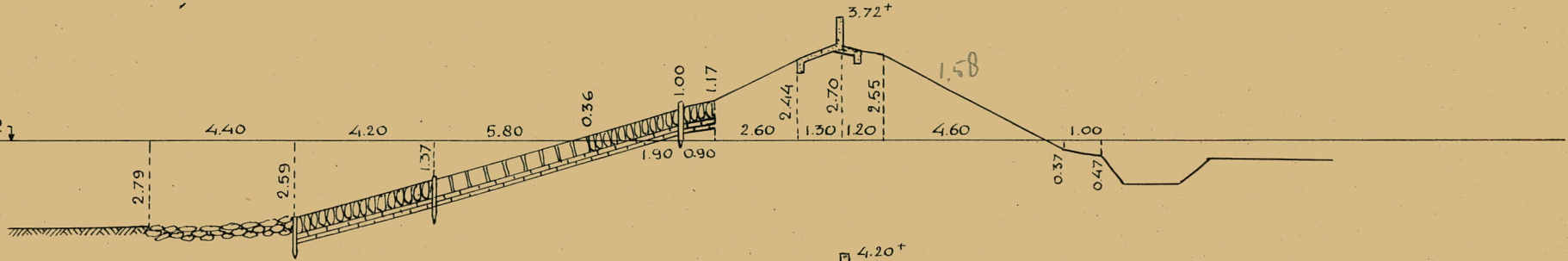

## Pr. SCHOUWEN

D.P. 18 - km. 53<sup>020</sup>

H.W. = 1.30 m<sup>+</sup> N.A.P.

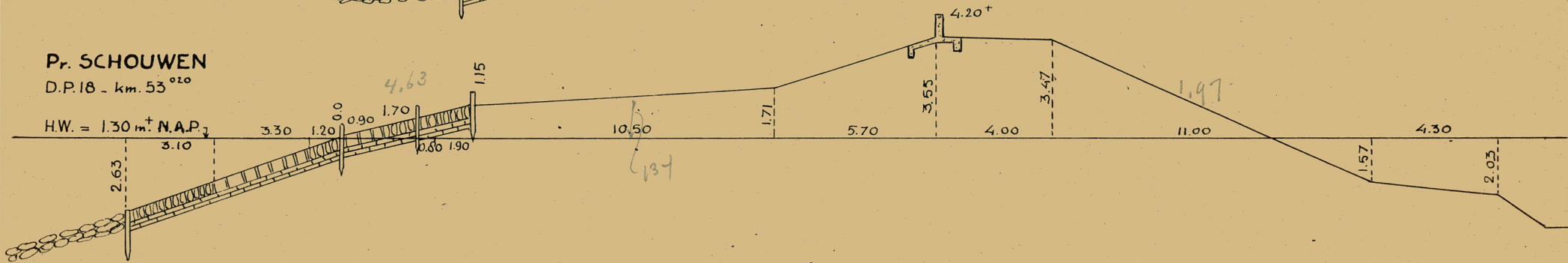

## WESTHAVENDIJK VAN Zr. ZEE

PIK. E - km. 60<sup>340</sup>

H.W. = 1.30 m<sup>+</sup> N.A.P.

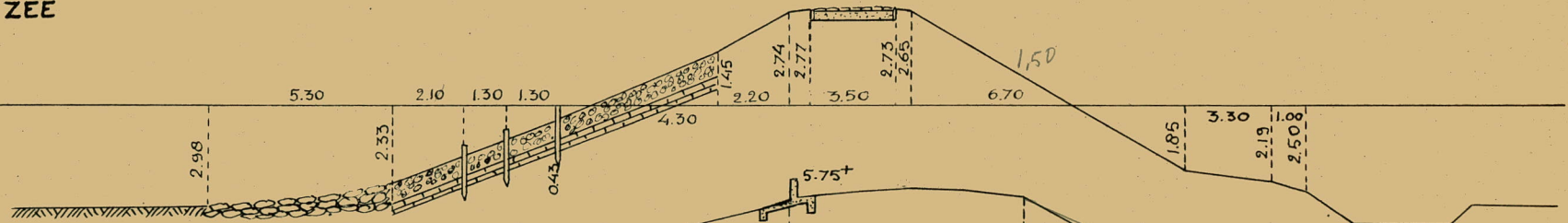

## Pr. SCHOUWEN

D.P. 12 - km. 62<sup>290</sup>

H.W. = 1.30 m<sup>+</sup> N.A.P.





# DWARSPROFIELEN SCHOUWEN EN DUIVELAND (8)

SCHAAL 1:200

Pr. SCHOUWEN

D.P. 34 - km. 64<sup>560</sup>

H.W. = 1.30 m<sup>+</sup> N.A.P.

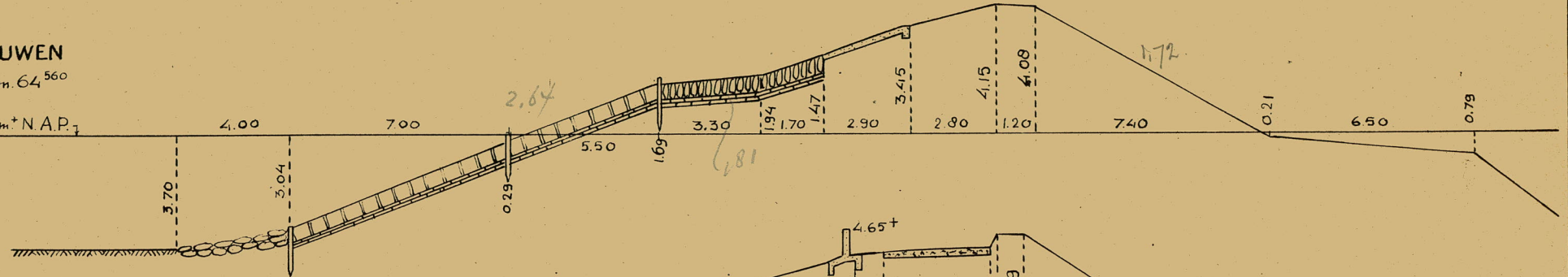

Pr. SCHOUWEN

D.P. 2 - km. 66<sup>790</sup>

H.W. = 1.29 m<sup>+</sup> N.A.P.

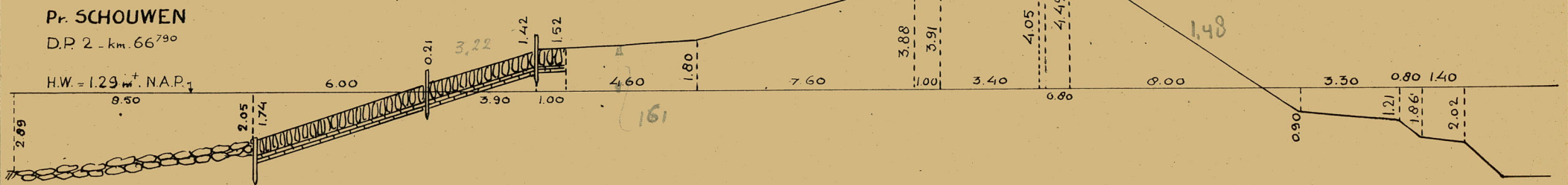

Pr. SCHOUWEN

D.P. 30 - km. 69<sup>580</sup>

H.W. = 1.29 m<sup>+</sup> N.A.P.

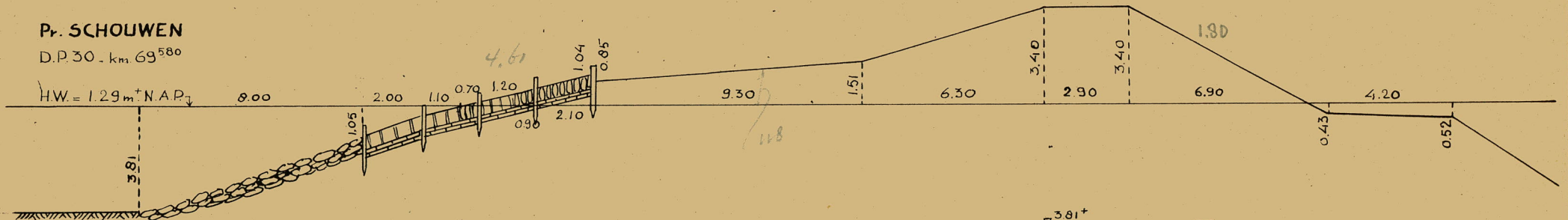

Pr. SCHOUWEN

D.P. 7 - km. 72<sup>380</sup>

H.W. = 1.29 m<sup>+</sup> N.A.P.

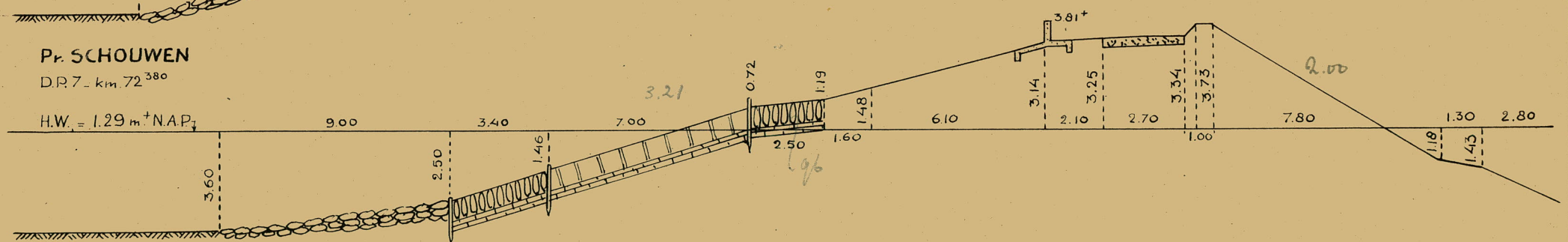

BULAGE

# DWARSPROFIELEN SCHOUWEN EN DUIVELAND (9-5LOT)

SCHAAL 1:200

## Pr. SCHOUWEN

D.P. 32 - km. 74<sup>000</sup>

H.W. = 1.29 m<sup>+</sup> N.A.P.

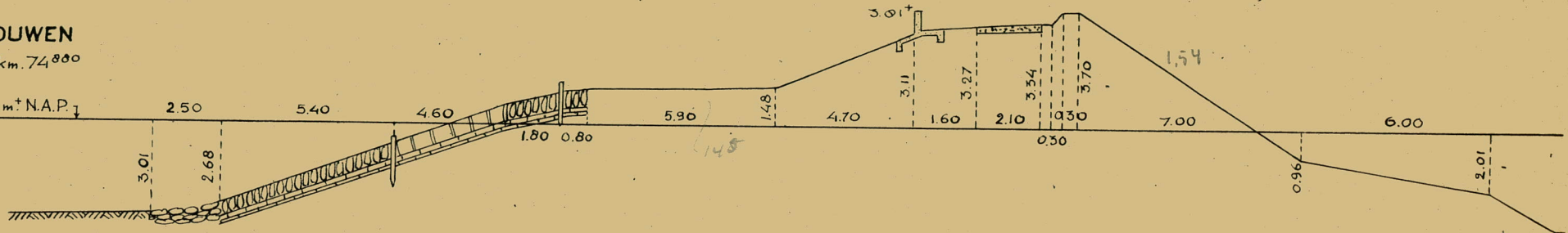

## BURGH EN WESTLAND Pr.

D.P. 4 - km. 76<sup>320</sup>

H.W. = 1.29 m<sup>+</sup> N.A.P.

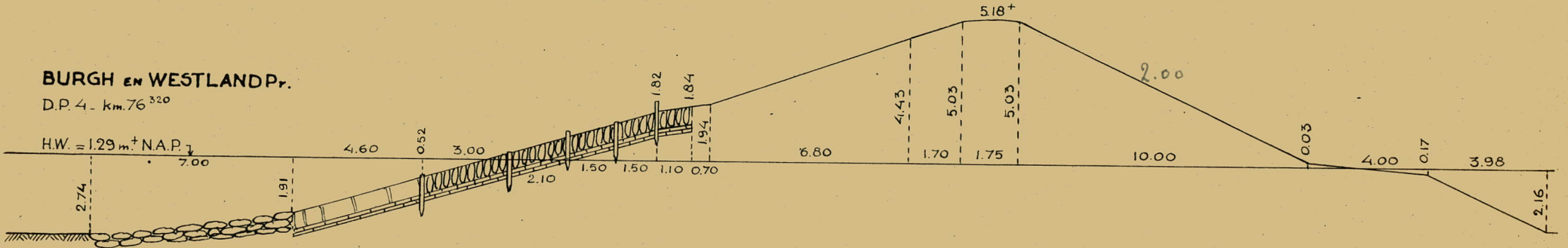

## BURGH EN WESTLAND Pr.

D.P. 27 - km. 78<sup>580</sup>

H.W. = 1.29 m<sup>+</sup> N.A.P.

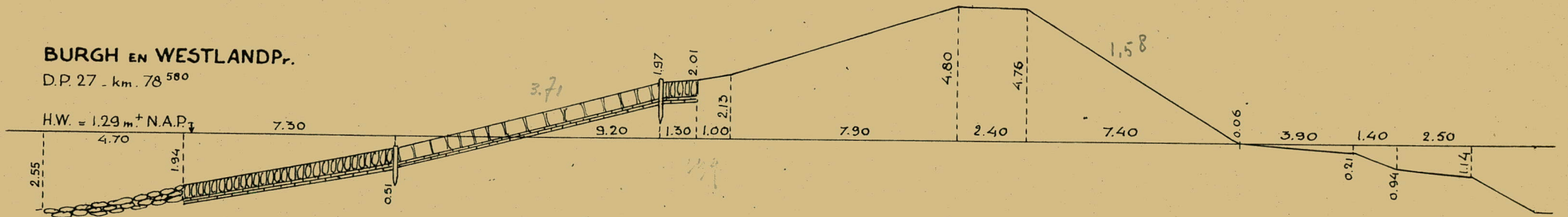

BILAGE



# GEM. DIJKSKRUINHOOGTE PER k.m.

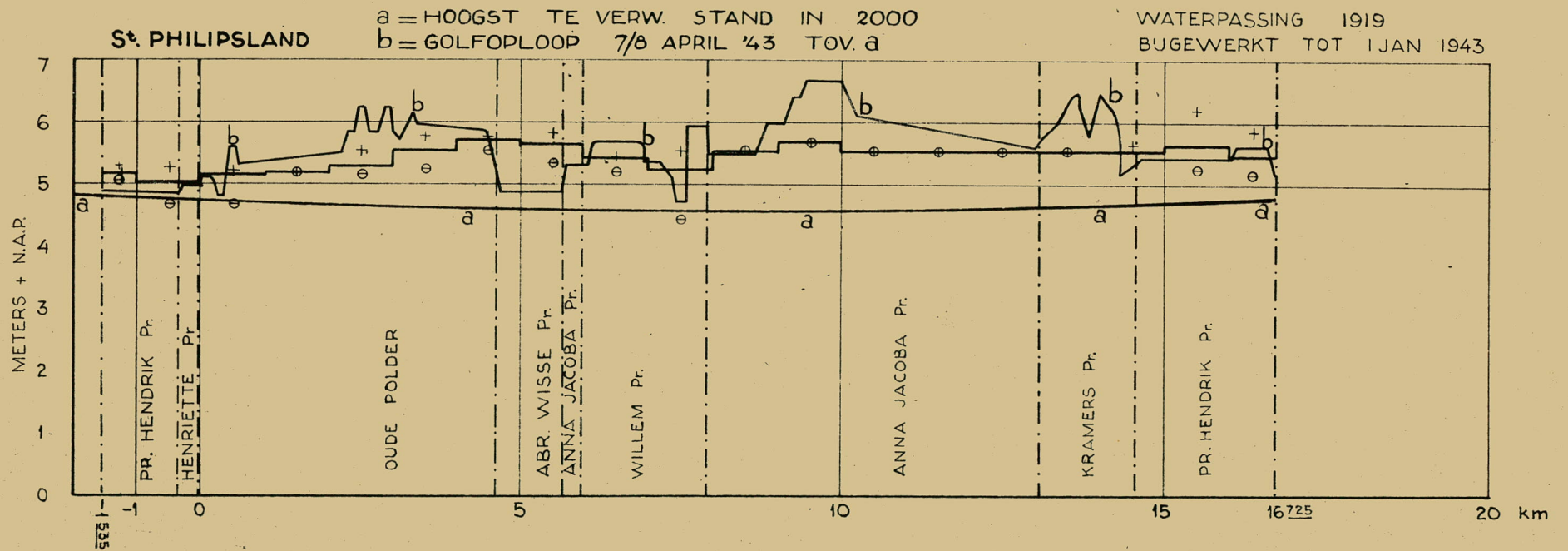

# DWARSPROFIELEN ST. PHILIPSLAND (1)

SCHAAL 1:200

OUDE Pr.

D.P. 5 - km. 0<sup>500</sup>

H.W. = 1.36 m<sup>+</sup> N.A.P.

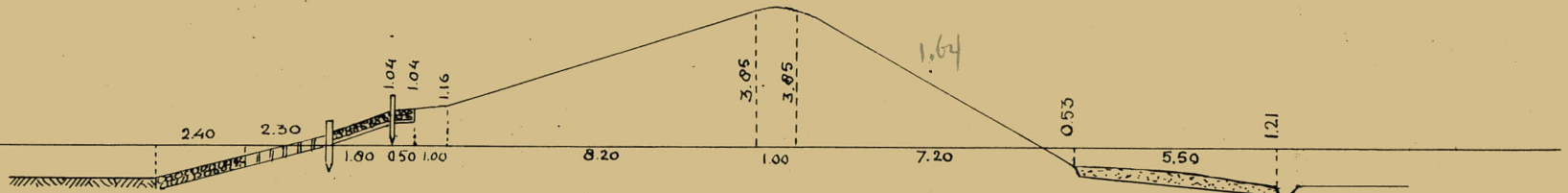

OUDE Pr.

D.P. 30 - km. 3<sup>040</sup>

H.W. = 1.36 m<sup>+</sup> N.A.P.

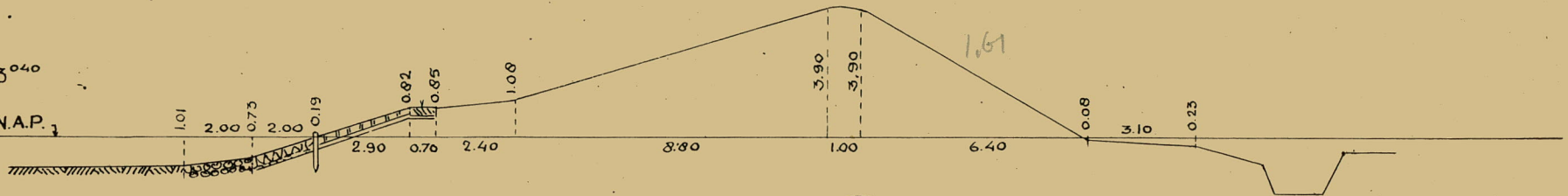

ABR. WISSE Pr.

D.P. 2 - km. 4<sup>850</sup>

H.W. = 1.36 m<sup>+</sup> N.A.P.

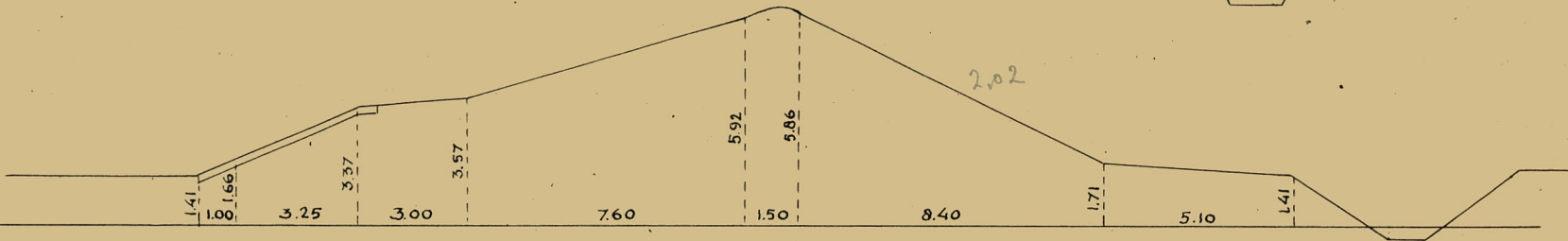

WILLEMPr.

D.P. 19 - km. 6<sup>550</sup>

H.W. = 1.36 m<sup>+</sup> N.A.P.

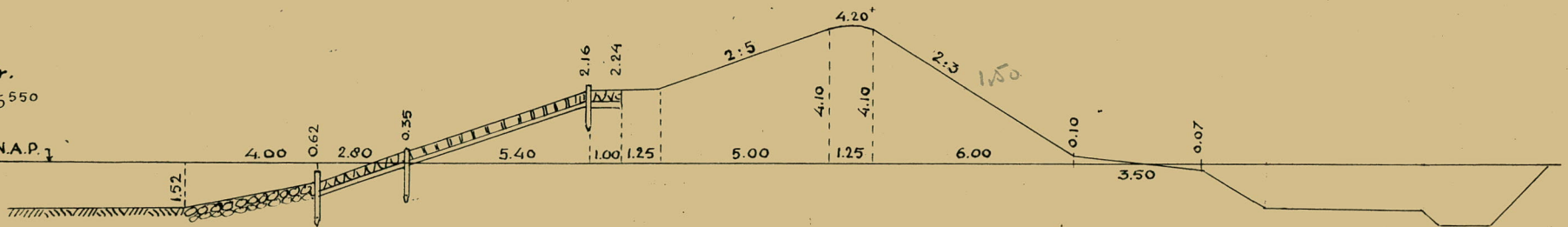

BYLAGE 57



# DWARSPROFIELEN ST. PHILIPSLAND (2 SLOT)

SCHAAL 1:200

ANNA JACOBAPr.

D.P. 35+32m. - km. 8<sup>650</sup>

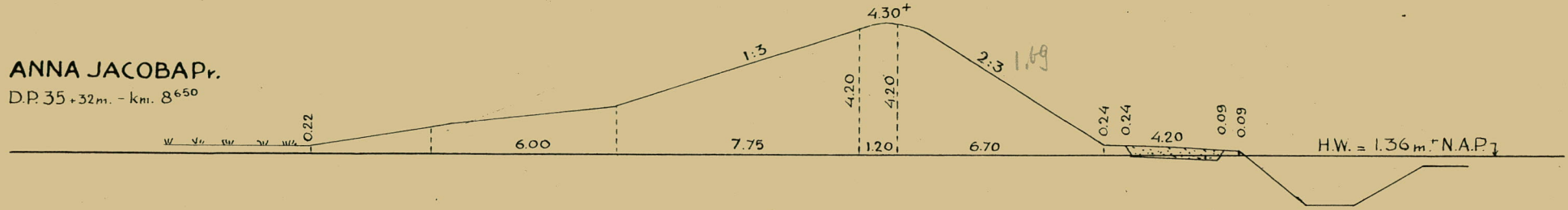

ANNA JACOBAPr.

D.P. 57+30m. - km. 10<sup>650</sup>

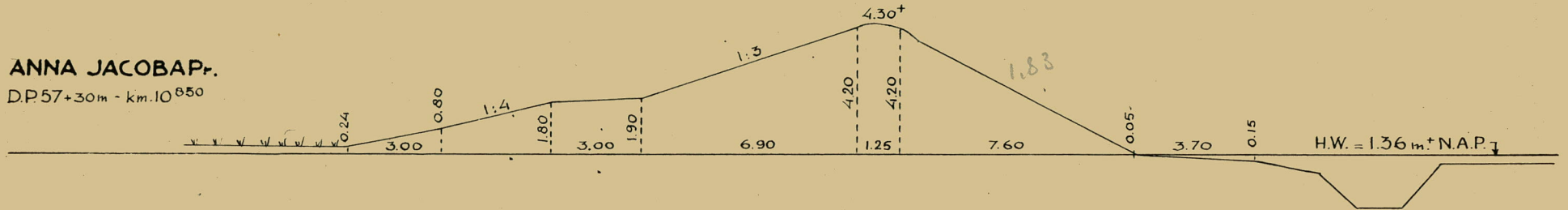

PR. HENDRIKPr.

D.P. 8 - km. 15<sup>275</sup>

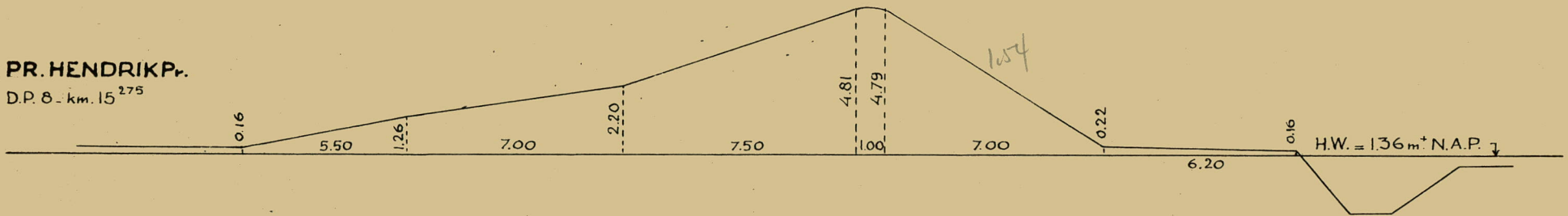

PR. HENDRIKPr.

D.P. 10 - km. 8<sup>545</sup>

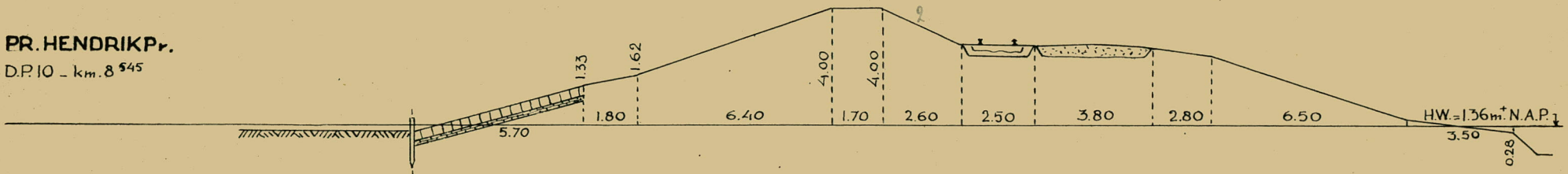

BULAGE h. 7

# Globale Analyse Zeeuwsche Duken

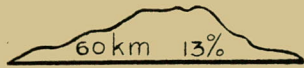

DUINKEERING



TOTAAL

GEM. DIJKSKRUIHOOGTE 5.61 m+NAP  
GEM. KEERHOOGTE 5.79 m+NAP



BESCHERMEND VOORLAND BOVEN H.W.



BUITENBERM BOVEN S.V.



BUITENBERM BENEDEN S.V.



VERDEDIGD TOT BOVEN S.V.

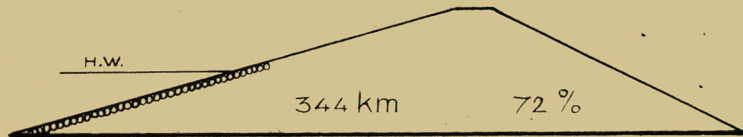

VERDEDIGD TOT BOVEN H.W.

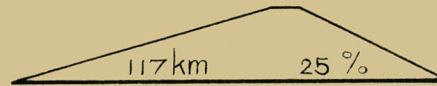

ONVERDEDIGD



BEBOUWDE DIJK

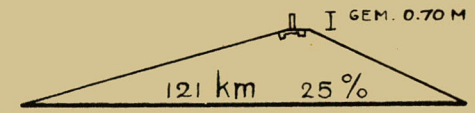

BETONMUUR

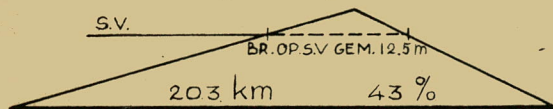

KRUIJN SMALLER DAN 1,50 m

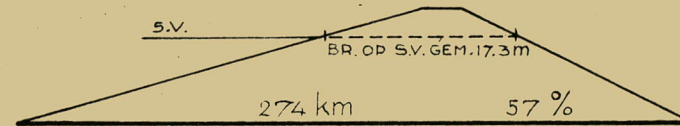

KRUIJN 1,50 m OF BREEDER

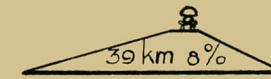

WEG OP DE KRUIJN

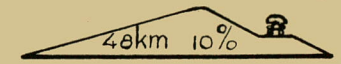

WEG OP DE BINNENBERM



BELOOP BOVEN H.W. FLAUWER DAN 2:7



BELOOP BOVEN H.W. 2:7 EN STEILER



KRUIJN LAGER DAN 6,5 m



4006 AI

KR. LAGER DAN 6 m

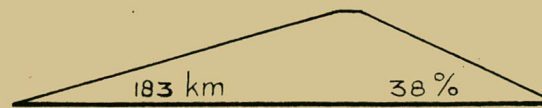

KR. LAGER DAN 5,5 m



KR. LAGER DAN 5 m



KR. LAGER DAN 4,5 m



# Globale Analyse Zeeuws-Vlaamse Dijken

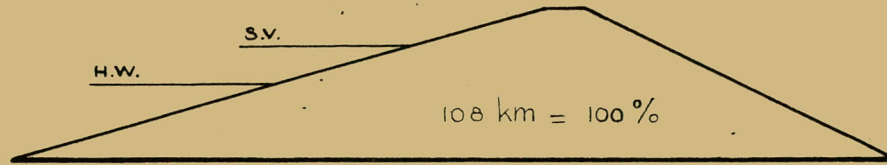

GEM. DIJKSKRUINHOOGTE 5.95 m+NAP.  
GEM. KEERHOOGTE 6.01 m+NAP.

TOTAAL



BESCHERMEND VOORLAND BOVEN H.W.



BUITENBERM BOVEN S.V.



BUITENBERM BENEDEN S.V.



VERDEDIGD TOT BOVEN S.V.



VERDEDIGD TOT BOVEN H.W.



ONVERDEDIGD



BEBOUWDE DIJK

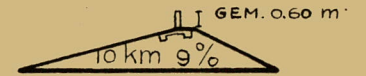

BETONMUUR



KRUIJN SMALLER DAN 1.50 M

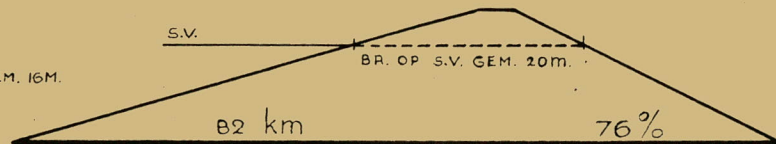

KRUIJN 1.50 M. OF BREEDER



WEG OP DE KRUIJN

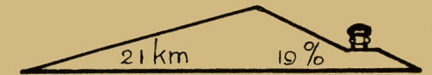

WEG OP DE BINNENBERM



BELOOP BOVEN H.W. FLAUWER DAN 2:7



BELOOP BOVEN H.W. 2:7 EN STEILER



KRUIJN LAGER DAN 6.5 M



KRUIJN LAGER DAN 6 M



KRUIJN LAGER DAN 5.5 M



KRUIJN LAGER DAN 5 M

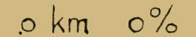

KRUIJN LAGER DAN 4.5 M

# Globale Analyse Zuidbevelandsche Duken

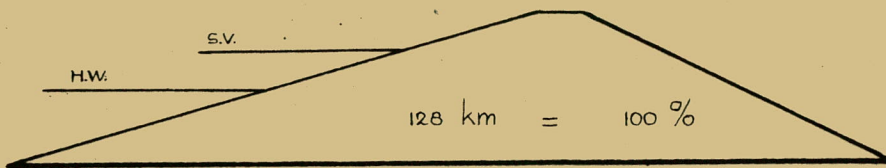

GEM. DUJKRUINHOOGTE 5.77m + NAP.  
GEM. KEERHOOGTE 6.07m + NAP.

128 km = 100 %

TOTAAL



BESCHERMEND VOORLAND BOVEN H.W.

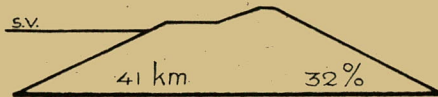

BUITENBERM BOVEN S.V.

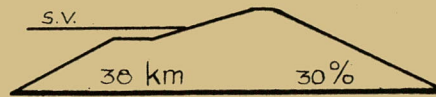

BUITENBERM BENEDEN S.V.



VERDEDIGD TOT BOVEN S.V.



VERDEDIGD TOT BOVEN H.W.

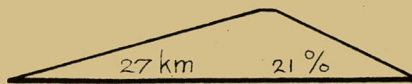

ONVERDEDIGD



BEBOUWDE DIJK

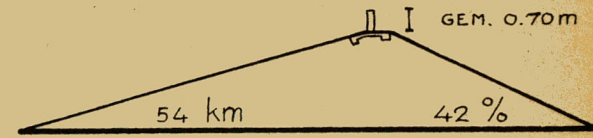

BETONMUUR

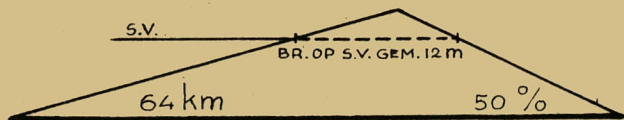

KRUIJN SMALLER DAN 1.50 m

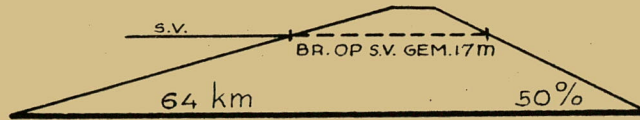

KRUIJN 1.50 OF BREEDER



WEG OP DE KRUIJN



WEG OP DE BINNENBERM



BELOOP BOVEN H.W. FLAUWER DAN 2:7



BELOOP BOVEN H.W. 2:7 EN STEILER

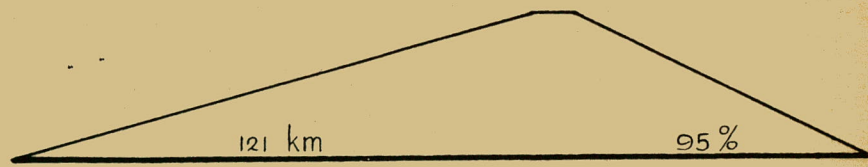

KRUIJN LAGER DAN 6.5m



KRUIJN LAGER DAN 6m

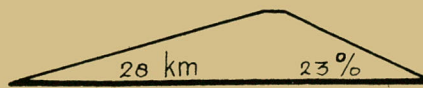

KRUIJN LAGER DAN 5.5 m



KRUIJN LAGER DAN 5m

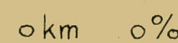

KRUIJN LAGER DAN 4.5m

4008 A1



# Globale Analyse Walchersche Duken

2 km 6%

KRUIN LAGER DAN 4.5 m

(FIG. BEHOORT ONDERAAN RECHTS)

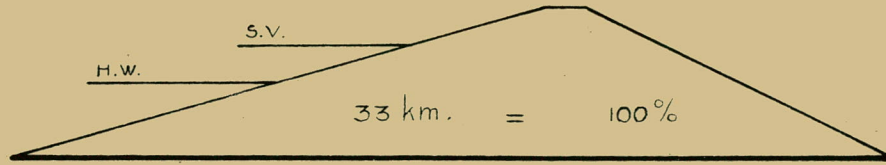

TOTAAL

GEM. DUJSKRUINHOOGTE 5.42 m + NAP

GEM. KEERHOOGTE 5.50 m + NAP



BESCHERMEND VOORLAND BOVEN H.W.

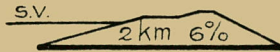

BUITENBERM BOVEN S.V.

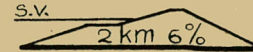

BUITENBERM BENEDEN S.V.

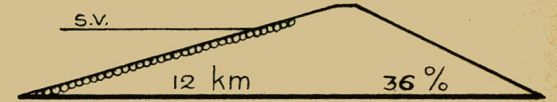

VERDEDIGD TOT BOVEN S.V.



VERDEDIGD TOT BOVEN H.W.



ONVERDEDIGD



BEBOUWDE DUJ

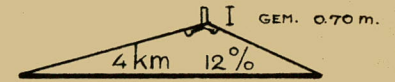

BETONMUUR

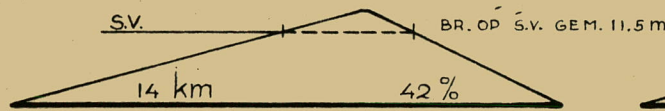

KRUIN SMALLER DAN 1.50 m

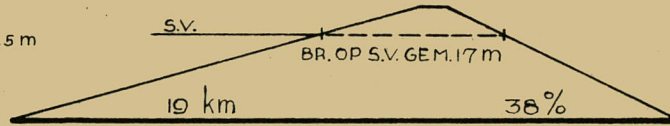

KRUIN 1.50 m OF BREEDER

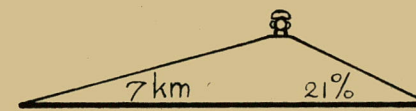

WEG OP DE KRUIN



WEG OP DE BINNENBERM



BELOOP BOVEN H.W. FLAUWER DAN 2:7

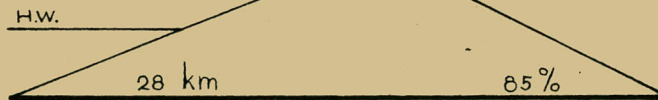

BELOOP BOVEN H.W. 2:7 OF STEILER



KRUIN LAGER DAN 6.5 m



4009 A1 KRUIN LAGER DAN 6 m



KRUIN LAGER DAN 5.5 m

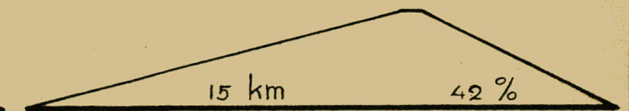

KRUIN LAGER DAN 5 m

BULAGE (11)

# Globale Analyse Noordbevelandsche Duken

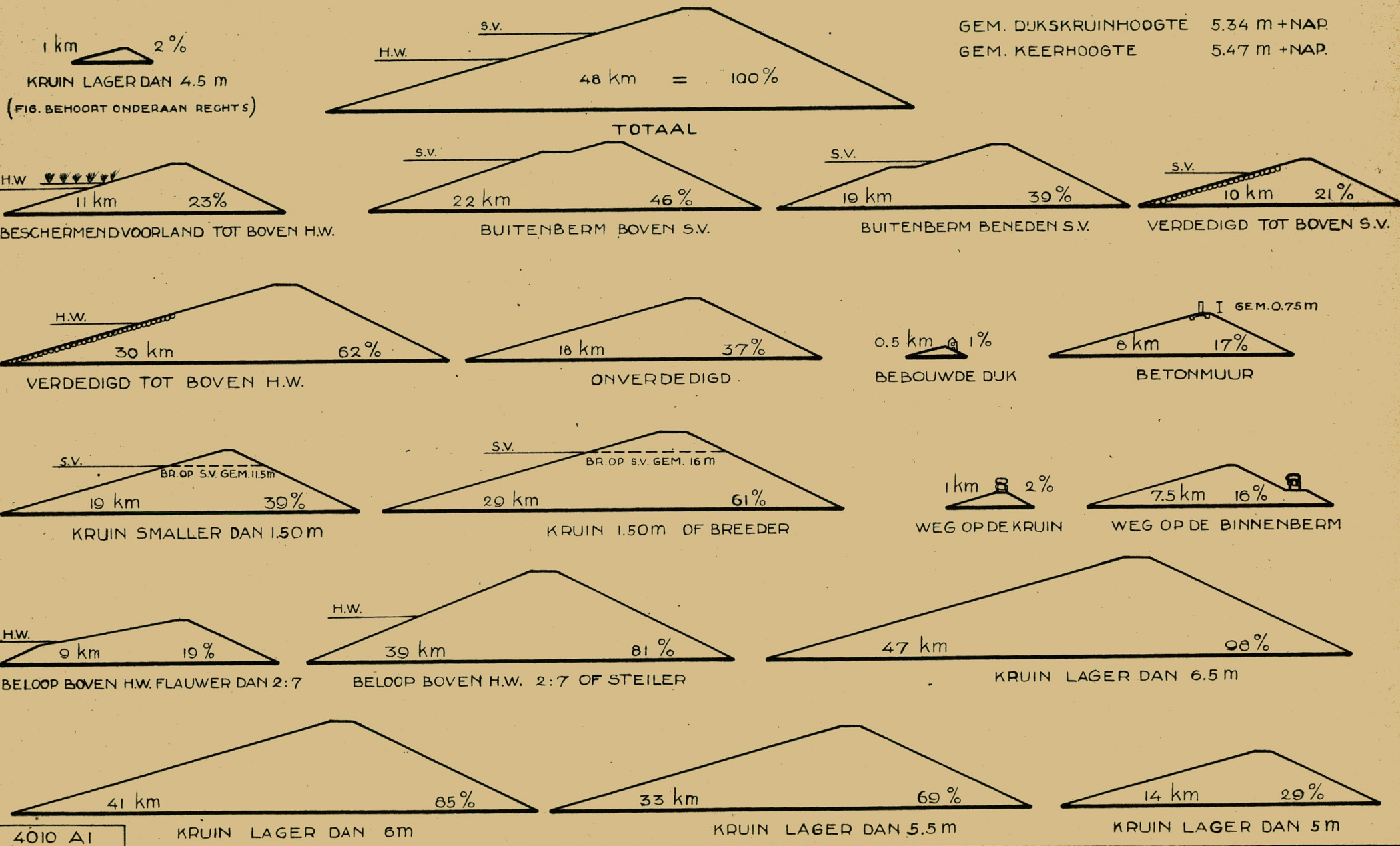

BILAGE 71



# Globale Analyse Tholensche Duken

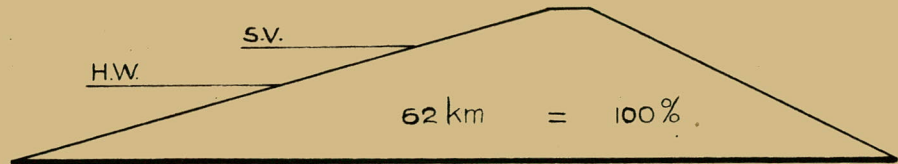

GEM. DUJKS KRUINHOOOGTE 5.62 m + NAP.  
 GEM. KEERHOOOGTE 5.70 m + NAP.



TOTAAL



BESCHERMEND VOORLAND BOVEN H.W.



BUITENBERM BOVEN S.V.



VERDEDIGD TOT BOVEN S.V.



VERDEDIGD TOT BOVEN H.W.

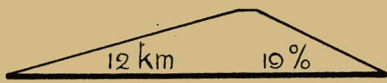

ONVERDEDIGD



BEBOUWDE DIJK

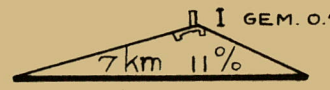

BETONMUUR

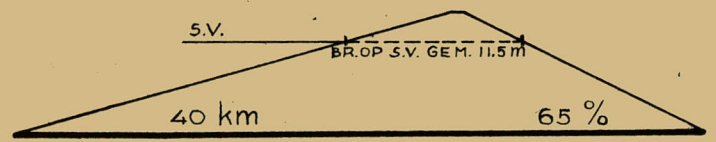

KRUIN SMALLER DAN 1.50 m

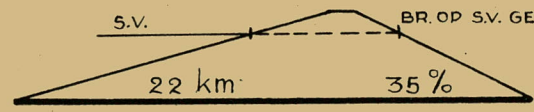

KRUIN 1.50 m OF BREEDER



WEG OP DE KRUIN



WEG OP DE BINNENBERM

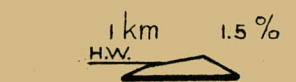

BELOOP BOVEN H.W. FLAUWER DAN 2:7



BELOOP BOVEN H.W. 2:7 OF STEILER



KRUIN LAGER DAN 6.5 m



KRUIN LAGER DAN 6 m

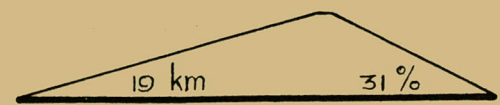

KRUIN LAGER DAN 5.5 m



KR. LAGER DAN 5 m



KR. LAGER DAN 4.5 m

BULAGE

# Globale Analyse Schouwen-Duivelandse Dijken



KRUIN LAGER DAN 4.5 m  
 (FIG. BEHOORT ONDERAAN RECHTS)

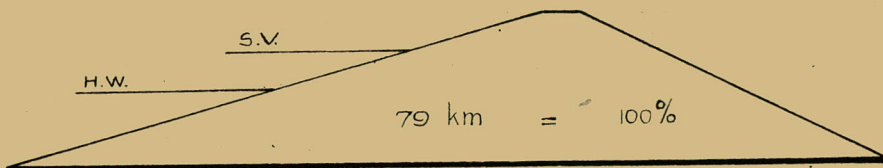

TOTAAL

GEM. DIJKSKRUINHOOGTE 5.16m+NAP.  
GEM. KEERHOOGTE 5.54m+NAP.



BESCHERMEND VOORLAND  
BOVEN H.W.



BUITENBERM BOVEN S.V.

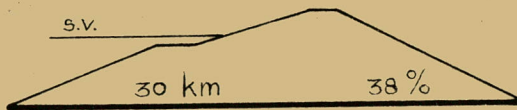

BUITENBERM BENEDEN S.V.



VERDEDIGD TOT BOVEN S.V.



VERDEDIGD TOT BOVEN H.W.



ONVERDEDIGD



BEBOUWDE DIJK

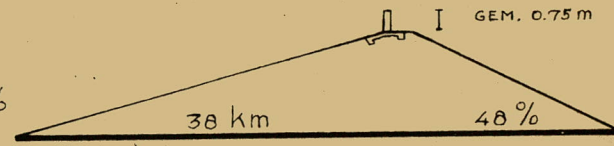

BETONMUUR

GEM. 0.75 m

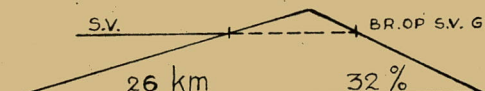

KRUIN SMALLER DAN 1.50m

BR. OP S.V. GEM. 13 m

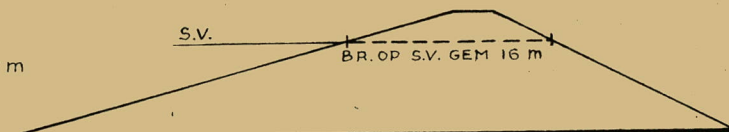

KRUIN 1.50 m OF BREEDER

BR. OP S.V. GEM 16 m

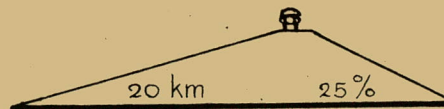

WEG OP DE KRUIN



WEG OP DE BINNENBERM



BELOOP BOVEN H.W. FLAUWER DAN 2:7



BELOOP BOVEN H.W. 2:7 EN STEILER



KRUIN LAGER DAN 6.5m.



4012 A1

KRUIN LAGER DAN 6m



KRUIN LAGER DAN 5.5 m



KRUIN LAGER DAN 5 m

BYLAGE 72



# Globale Analyse S<sup>t</sup> Filipslandsche Duken

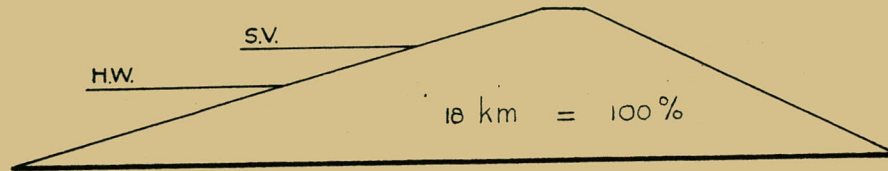

GEM. DIJKSKRUINHOOGTE 5.46 m + NAP  
 GEM. KEERHOOGTE 5.46 m + NAP

TOTAAL

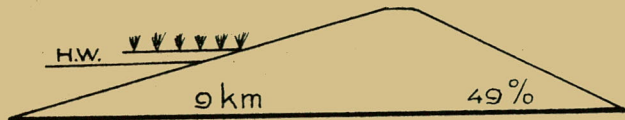

BESCHERMEND VOORLAND BOVEN H.W.



BUITENBERM BOVEN S.V.

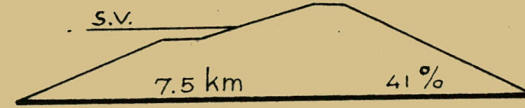

BUITENBERM BENEDEN S.V.



VERDEDIGD TOT BOVEN S.V.



VERDEDIGD TOT BOVEN H.W.



ONVERDEDIGD



BEBOUWDE DIJK

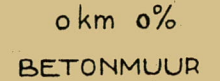

BETONMUUR

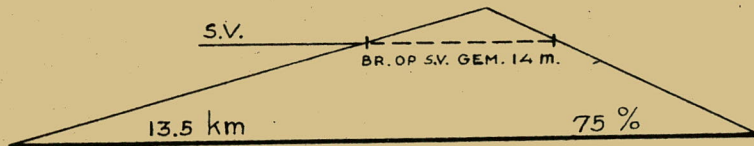

KRUIJN SMALLER DAN 1.50 m.

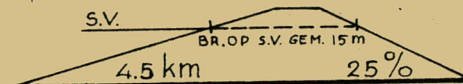

KRUIJN 1.50 m OF BREEDER

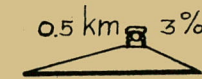

WEG OP DE KRUIJN

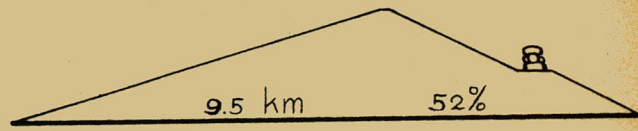

WEG OP DE BINNENBERM

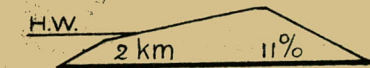

BELOOP BOVEN H.W. FLAUWER DAN 2:7



BELOOP BOVEN H.W. 2:7 OF STEILER



KRUIJN LAGER DAN 6.5 m

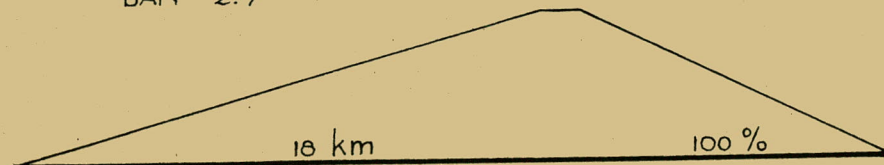

KRUIJN LAGER DAN 6 m



KRUIJN LAGER DAN 5.5 m



KRUIJN LAGER DAN 5 m



# ONDERLINGE VERGELUKING ZEEUWSCHE DUKEN

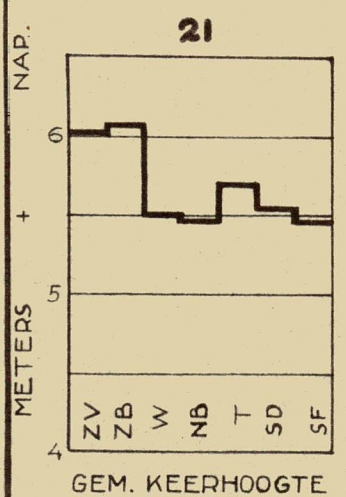
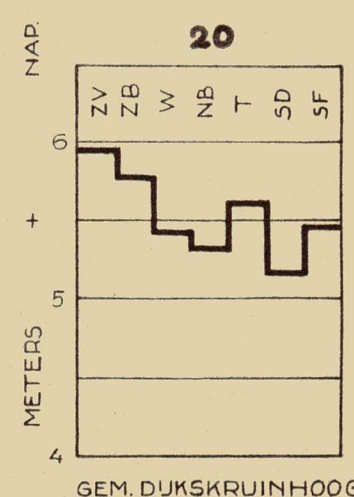
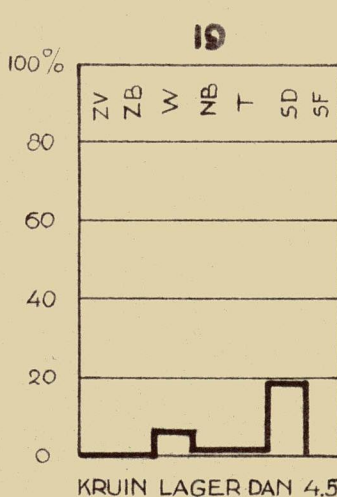
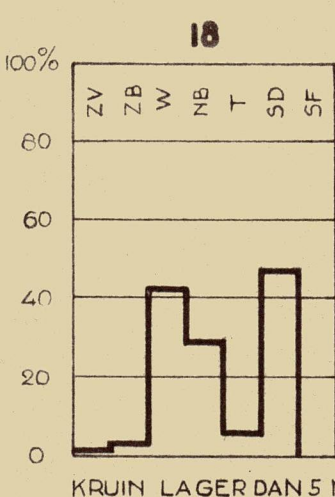
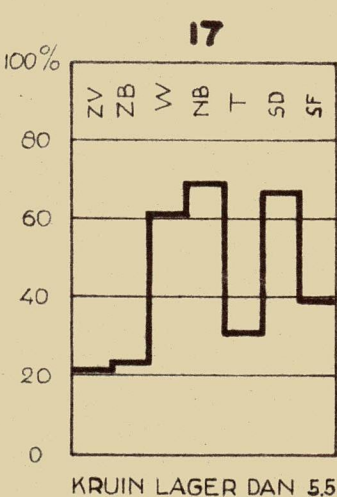
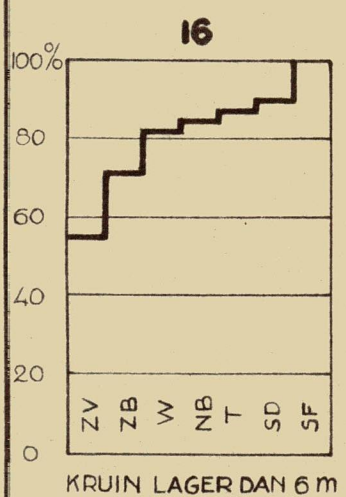
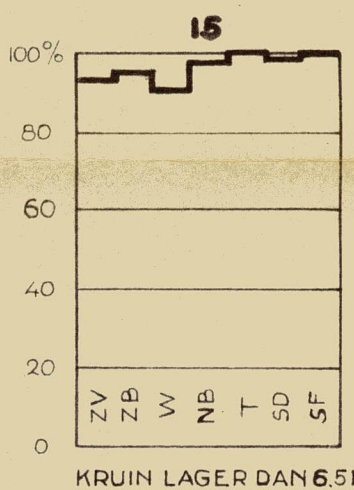
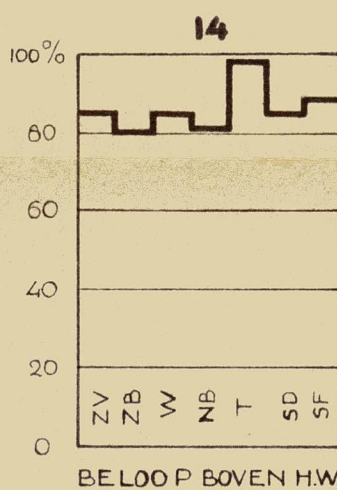
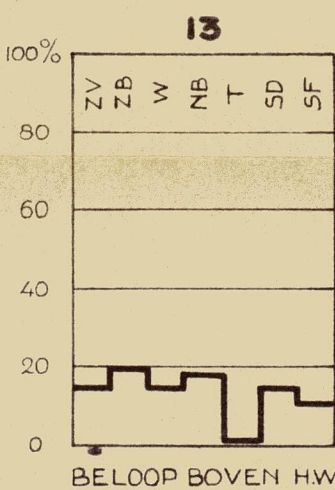
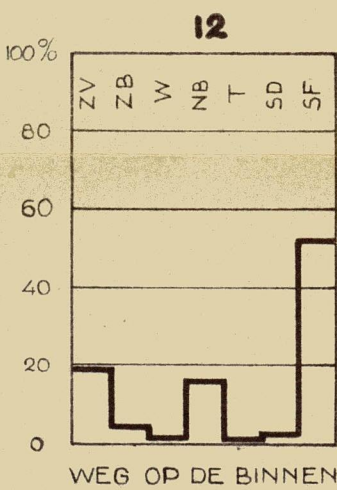
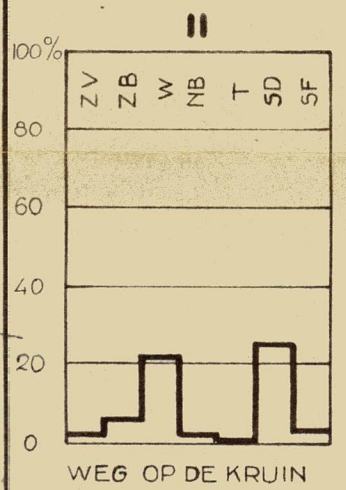
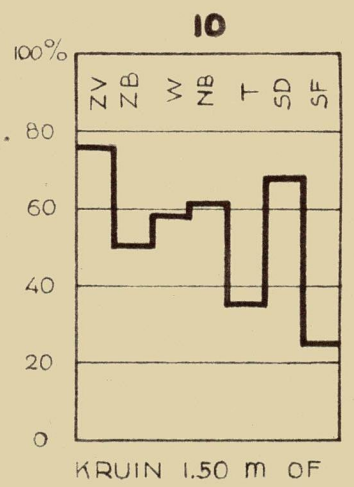
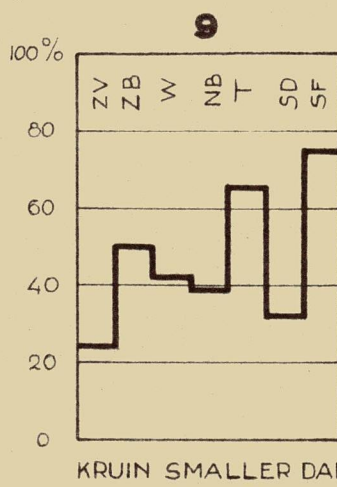
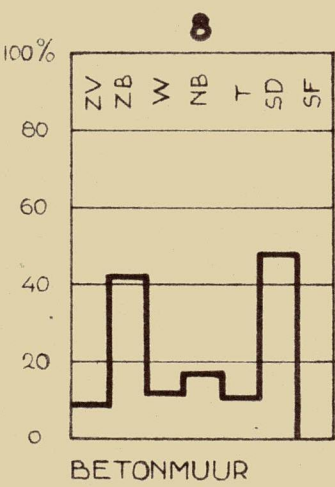
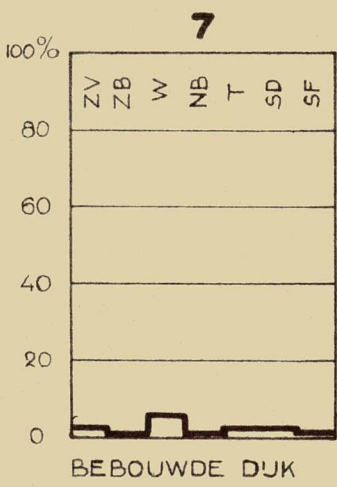
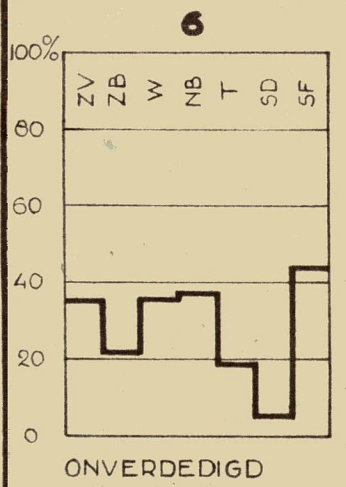
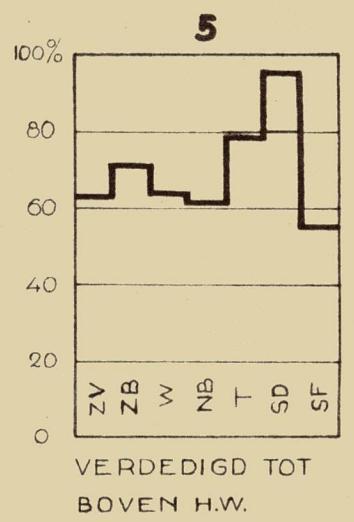
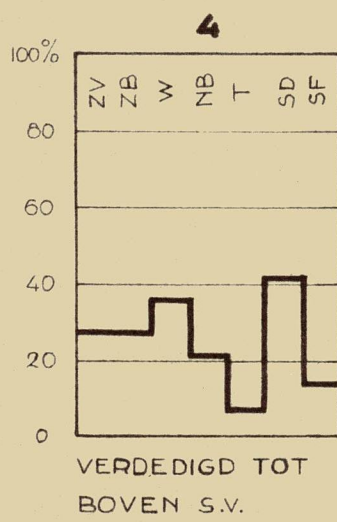
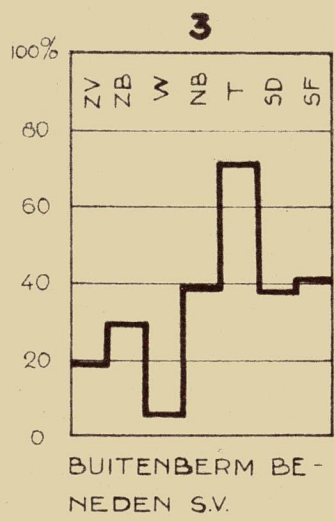
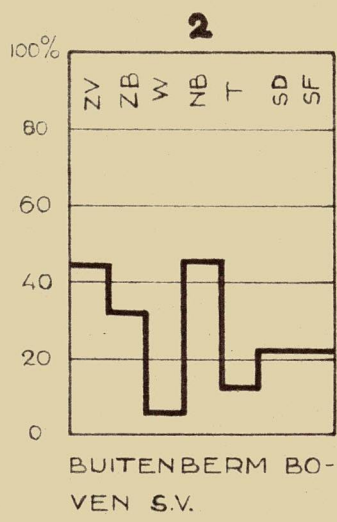
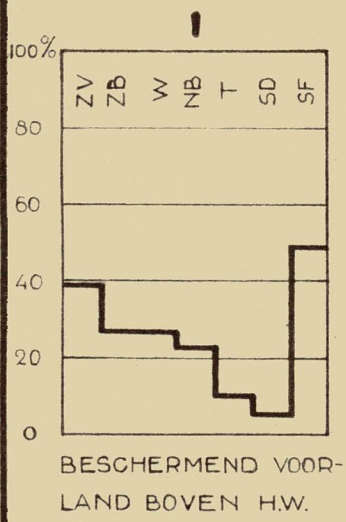

### TOELICHTING

- ZV = ZEEUWSCH VLAANDEREN
- ZB = ZUID BEVELAND
- W = WALCHEREN
- NB = NOORD BEVELAND
- T = THOLEN
- SD = SCHOUWEN DUIVELAND
- SF = SINT FILIPSLAND

ALLE PERCENTAGES HEBBEN BETREKKING OP DE TOTALE DIJKLENGTE VAN HET BETREFFENDE EILAND

DE GEMIDDELDE KEERHOOGTE IS BEPAALD UIT KRUIJNSHOOGTE + BETONNEN KEERMUREN



# ZEELAND

## GLOBAL GEMIDDELDE DIKSPROFIELEN

*Binnenbeloop*

Van Geen Vlaanderen : 1:1,87  
 Van Scherpen Duiweland : 1:1,71  
 Van Noordvliet : 1:1,68

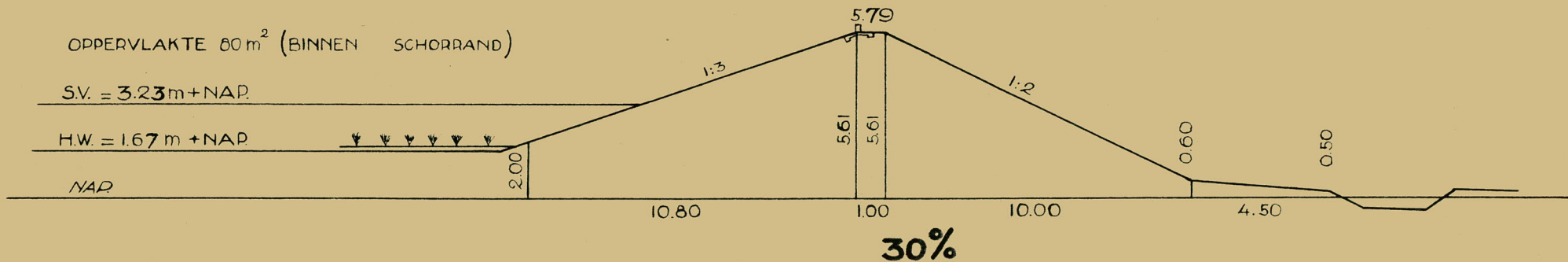
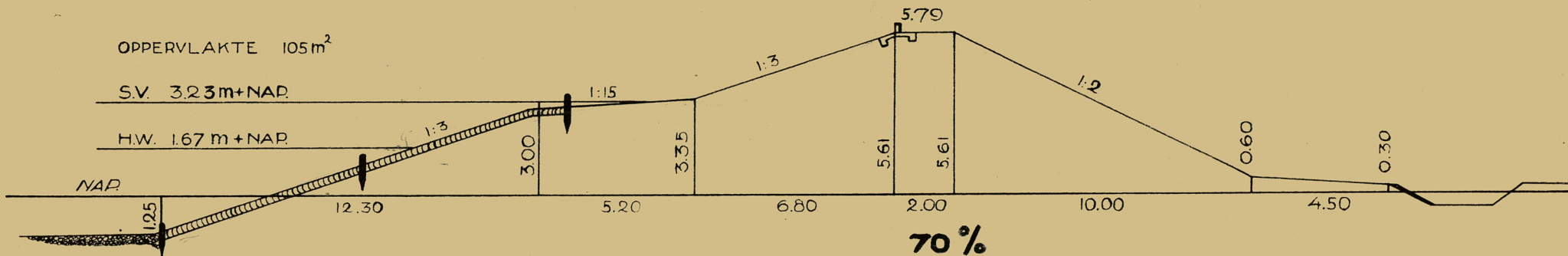















# VERBAND TUSSCHEN GEM. GOLFOPLOOP EN DIJKPROFIEL

GEMIDDELDE GOLFOPLOOP VAN  
DE STORM VAN 7/8 APRIL '43

**A**

120  
110  
100m  
090  
080  
070  
060

**B**

100%  
95%  
90%  
85%  
80%  
0%

**C**

10%  
20%  
30%  
40%  
50%

BUITENBELOOP BOVEN H.W.  
2:7 EN STEILER IN % VAN  
DE TOTALE LENGTE.

BUITENBERM BOVEN S.V.  
AANWEZIG OVER .....% VAN  
DE TOTALE LENGTE.

ZEEUWSCH VLAANDEREN.

ZUID BEVELAND

WALCHEREN.

NOORD BEVELAND.

THOLEN.

SCHOUWEN DUIVELAND

ST. FILIPSLAND.